



PRODUCT CATALOGUE



YAPARLAR

Since 1947...

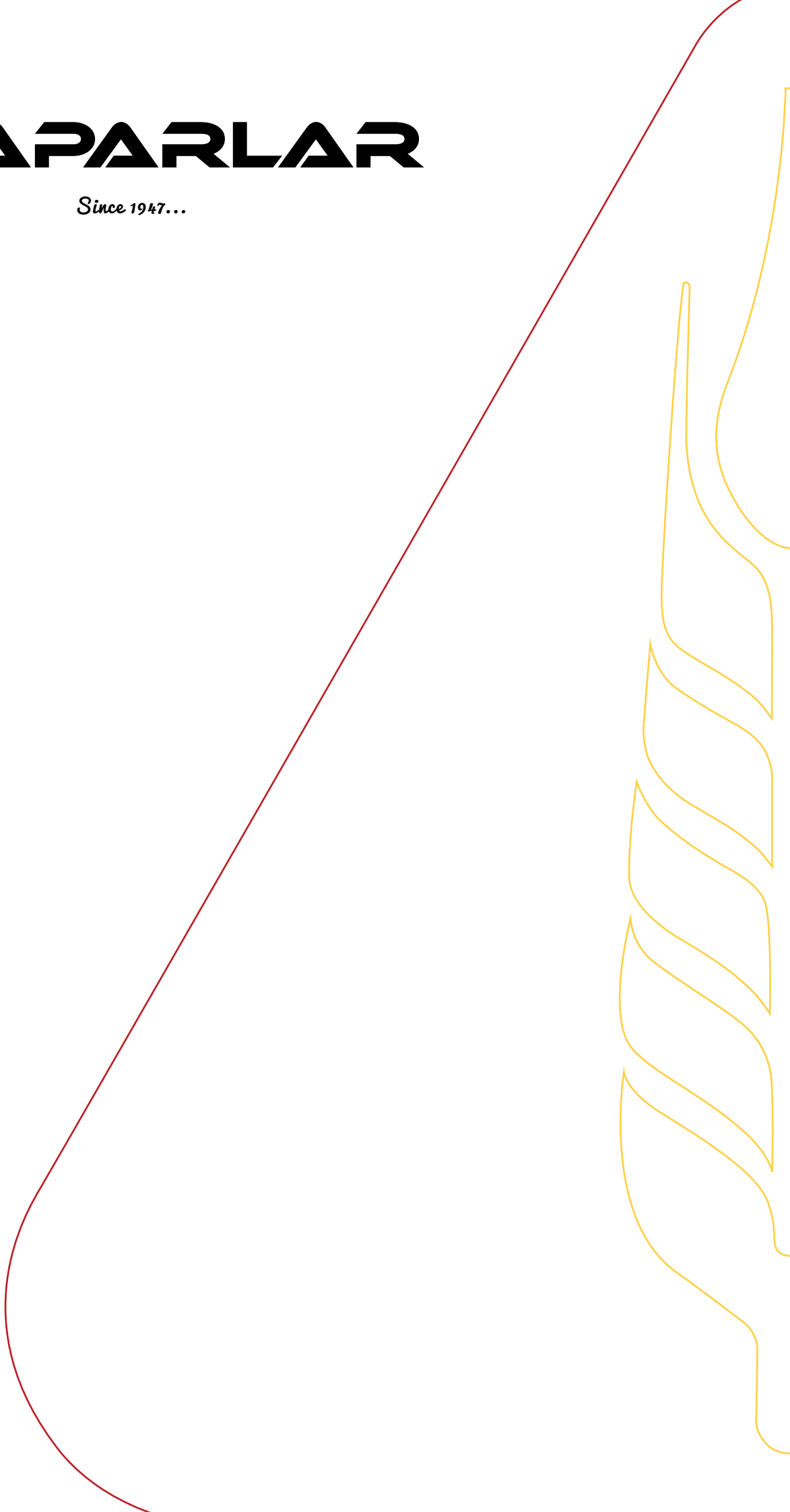



 **YAPAR**

 **YPR**

 **YKS**

FUZE





1947 yılında Mehmet Lütfi Yapar tarafından kurulan YAPARLAR A.Ş. tüketici memnuniyeti odaklı kalite anlayışı ile istikrarlı bir şekilde gelişerek faaliyet alanındaki lider kuruluş haline gelmiştir.

İnşaat ve tarım sektörleri için imal ettiği kaliteli ürünlerle ülkemizde ve ihracat yaptığı ülkelerde aranan marka haline gelen YAPARLAR, müşteri ihtiyaçları ve beklentileri doğrultusunda ürettiği fonksiyonel kürekler, tırmıklar, ahşap saplar, el arabaları, koli taşıma arabaları, tekerlekler ve çeşitli el aletleri ile müşterilerine geniş bir ürün yelpazesi sunmaktadır.

Tasarım ve imalat aşamalarında son teknoloji makine ve teçhizatlar kullanarak uluslararası standartlarda üretim gerçekleştiren YAPARLAR, sektördeki gelişmeleri yakından takip ederek ürünlerini piyasa şartlarına göre sürekli geliştirmekte ve ürün gamını yeni ürünlerle zenginleştirmektedir.

Yarım asrı aşkın bir süredir kalite, güven ve istikrarı kurum değerleri olarak benimseyen YAPARLAR, uluslararası pazardaki gücünü her geçen gün daha da artırmaktadır.

Yaparlar A. S., основанная в 1947 году Мехметом Лютфи Япаром (Mehmet Lutfi YAPAR), стала ведущей организацией в своей области деятельности, последовательно развиваясь с ориентированным на клиента чувством качества.

Благодаря качественной продукции, производимой для строительной и сельскохозяйственной отраслей, YAPARLAR (ЯПАРЛАР) стала востребованным брендом в нашей стране и в странах, которые она экспортирует. YAPARLAR предлагает своим клиентам широкий ассортимент продукции с функциональными лопатами, граблями, деревянными черенками, тачками и различными ручными инструментами в соответствии потребностям и ожиданиям клиентов.

Производству в высокими международными стандартами с использованием машины и инструменты технологии режущей кромки во время проектирования и производства, YAPARLAR следует за развитие отрасли, совершенствует свою продукцию в соответствии с конъюнктурой рынка и обогащает ее ассортимент продукции с новыми продуктами.

Приняв качество, доверие и последовательность в качестве корпоративных ценностей на протяжении более чем полувека, YAPARLAR увеличивает свою силу на международном рынке.

تأسست شركة يابارلار (YAPARLAR) من قبل محمد لطفي يابار في عام 1947 ، وتطورت بشكل مستقر مع إدراك الجودة والتركيز على رضا الزبون وقد أصبحت مؤسسة رائدة في هذا المجال.

أصبحت يابارلار (YAPARLAR) علامة تجارية مرغوبة في بلدنا وفي البلدان التي يتم التصدير إليها وذلك مع منتجات ذات جودة عالية والتي يتم إنتاجها من أجل قطاعات البناء والزراعة ، وتعرض يابارلار منتجاتها لزبائننا على نطاق واسع مثل المجرفات والكاسحات والمقابض الخشبية و العربات اليدوية و تجهيزات يدوية متنوعة ، ويتم توظيف ما نقوم بإنتاجه لتلبية إحتياجات وتوقعات الزبائن.

تقوم يابارلار (YAPARLAR) بالتصنيع حسب المعايير العالمية باستخدام تجهيزات و آلات بأحدث أنواع التكنولوجيا في مراحل التصميم والإنتاج ، وتقوم يابارلار بإغناء هذا القطاع بمنتجات حديثة من مجموعة منتجاتها و تقوم بالتطوير المستمر وفقا لشروط السوق ومراقبة التطورات عن قرب.

تعتمد يابارلار (YAPARLAR) لأكثر من نصف قرن من الزمان على القيم المؤسسية المستقرة وذات الجودة والموتوقية العالية، كما أن قوتها في السوق العالمية تزداد يوما بعد يوم.

YAPARLAR A.Ş., founded in 1947 by Mehmet Lutfi Yapar, became the leading organization in its field of activity by consistently developing with its customer oriented sense of quality.

With the quality products produced for construction and agriculture industries, **YAPARLAR** became a wanted brand in our country and in the countries it exports. **YAPARLAR** offers a wide product range for its customers with functional shovels, rakes, wooden handles, wheelbarrows, hand trucks, wheels and various types of hand tools in line with customer needs and expectations.

Producing in the highest international standards by using cutting edge technology machines and tools during design and production, **YAPARLAR** follows the developments in the industry, improves its products according to market conditions and enriches its product range with new products.

Having adopted quality, trust and consistency as corporate values for more than half century,

YAPARLAR increases its power in the international market.

Fondée en 1947 par Mehmet Lutfi Yaparlar, YAPARLAR Inc. est devenue la principale entreprise avec une approche de qualité orientée sur la satisfaction du client.

Avec ses produits pour les domaines de construction et d'agriculture, YAPARLAR est devenue la marque recherchée dans notre pays ainsi que dans les pays étrangers. Avec des pelles fonctionnelles, des râpeaux, des manches en bois, des brouettes et d'autres outils à main, YAPARLAR offre une large gamme de produits à ses clients pour les satisfaire.

En utilisant les matériaux et machineries de dernière technologie, YAPARLAR réalise la production suivant des standards internationaux, et enrichit sa gamme de produits en fonction des conditions du marché en suivant les développements du secteur.

Etant adopté la qualité, la fiabilité et la stabilité pour plus d'un demi-siècle, YAPARLAR augmente sa force, chaque jour, sur le marché international.



INDEX

İÇİNDEKİLER / INDICE / المحتويات / Индекс



07

WELDED WHEELBARROWS

Kaynaklı El Arabaları | Brouettes Soudés | العربات اليدوية الملحومة
Сварные Тачки

13

DEMONTABLE WHEELBARROWS

Demonte El Arabaları | Brouette Démonté | العربات اليدوية القابلة للفك
Демонтируемые Тачки

25

HAND TRUCKS

Koli Taşıma Arabası | Diablos | عربة نقل الامتعة
Ручные Тележки

29

WHEELS AND SPARES

Tekerlekler-Yedekler | Roues et Rechanges | عجلات وقطع الغيار
Колеса И Запасные Части

37

SHOVELS

Kürekler | Pelles | المجارف
Лопаты

59

HANDLES

Saplar | Poignées | المقابض
Черенки

65

GARDEN TOOLS

Bahçe Ekipmanları | Outils De Jardin | أدوات الحدائق
Садовые Инструменты

73

CONSTRUCTION EQUIPMENTS

İnşaat Ekipmanları | Équipements de Construction | معدات الطيان و النجار
Строительные Оборудования.



WELDED WHEELBARROWS

Kaynaklı El Arabaları Brouettes Soudés

العربات اليدوية الملحومة
Сварные Тачки

Starting production of wheelbarrows for professional use with wholly welded, trivet wheelbarrows, YAPARLAR improved its welded wheelbarrows product range considering different areas of use and started the production of wheelbarrows with various sheet thicknesses and trivet.

Tamamen kaynaklı, saç ayaklı el arabasıyla profesyonel kullanım amaçlı el arabası üretimine başlayan YAPARLAR, farklı kullanım alanlarını düşünerek kaynaklı el arabası ürün gamını geliştirmiş; değişik saç kalınlıklarına sahip, boru ayaklı el arabası üretimine ve sera arabası imalatına başlamıştır.

YAPARLAR qui a commencé de produire des Brouette pour l'utilisation professionnel avec le Brouette avec le piédestal en acier; a commencé de fabriquer des serres et piédestals aux jambes de tuyaux avec di.érentes épaisseurs d'acier.

یابارلار التي بدأت مع العربات اليدوية ذات الأرجل من الصفائح الحديدية الملحومة بشكل كامل بإنتاج العربات اليدوية بهدف الاستعمال المهني، قامت بتطوير نطاق إنتاجها من العربات اليدوية الملحومة آخذة بالحسبان أهداف الاستخدام المختلفة، بدأت بإنتاج العربات اليدوية ذات الأرجل من البواري وتصنيع العربات المستخدمة في البيوت البلاستيكية ذات تخانات الصفائح الحديدية المتنوعة.

Начало производства тачек для профессионального использования со стопроцентно сварной, опорной стойкой тачки, YAPARLAR улучшила свой ассортимент сварных тачек рассматривая различные области применения, было начато и производство тачек с различной толщиной листа и подставки.

SHIPMENT INFORMATION

Nakliye Bilgisi

Bundle Qty. Bağ Adedi	20' DC	40' HC	Truck Kamyon	Jumbo Truck Tır
1 pcs./Adet	120 pcs./Adet	300 pcs./Adet	250 pcs./Adet	410 pcs./Adet



Code / Kod / Code / Код
الرمز



Tekne Sac Kalınlığı / Tray Thickness / Caisse épaisseur / Толщина Лотка
سمك جدار الحوض



Chassis / Şasi / Châssis / Шасси
الهيكل



Wheel Type / Tekerlek Tipi / Type de Roue / Тип Колеса
نوع العجلة



Weight / Ağırlık / Poids / Вес
الوزن



Bundle Qty. / Bağ Adedi / Botte Quantité / Количество Пачки
عدد الربطة

90L

YAPAR PRO WHEELBARROWS 

YAPAR PRO EL ARABALARI / BROUETTE YAPAR PRO
عربات يابار برو / YAPAR PRO тачки



↔	🍲	~	⊙	📦	⊞
51331	1,20 mm	Ø 32 x 2,00 mm	Semi Solid w/ Bushing	17,10 kg	1
51361	1,20 mm	Ø 32 x 2,00 mm	Semi Solid w/ B. Bearing	17,20 kg	1
51631	1,20 mm	Ø 32 x 2,00 mm	Pneumatic w/ Bushing (3,50 x 7)	15,75 kg	1
51161	1,20 mm	Ø 32 x 2,00 mm	Pneumatic w/ B. Bearing (3,50 x 7)	15,95 kg	1
51931	1,20 mm	Ø 32 x 2,00 mm	Pneumatic w/ Plastic Rim (3,50 x 7)	16,30 kg	1
51771	1,20 mm	Ø 32 x 2,00 mm	Pneumatic w/ B. Bearing (3,50 x 8)	16,80 kg	1

120L

YAPAR 3000 WHEELBARROWS 

YAPAR 3000 EL ARABALARI / BROUETTE YAPAR 3000
3000 عربات يابار / YAPAR 3000 тачки



↔	🍲	~	⊙	📦	⊞
32321	1,20 mm	Ø 32 x 2,00 mm	Semi Solid w/ Bushing	18,90 kg	1
32601	1,20 mm	Ø 32 x 2,00 mm	Semi Solid w/ B. Bearing	19,00 kg	1
33321	1,20 mm	Ø 32 x 2,00 mm	Pneumatic w/ Bushing (3,50 x 7)	17,55 kg	1
33601	1,20 mm	Ø 32 x 2,00 mm	Pneumatic w/ B. Bearing (3,50 x 7)	17,75 kg	1
34601	1,20 mm	Ø 32 x 2,00 mm	Pneumatic w/ Plastic Rim (3,50 x 7)	18,10 kg	1
35601	1,20 mm	Ø 32 x 2,00 mm	Pneumatic w/ B. Bearing (3,50 x 8)	18,60 kg	1





90L

YPR 120 WHEELBARROWS



YPR 120 EL ARABALARI / BROUETTE YPR 120
120 YPR عربات / YPR 120 Тачки



						
59331	1,20 mm	Ø 32 x 1,50 mm	Semi Solid w/ Bushing	15,50 kg	1	
59731	1,20 mm	Ø 32x 1,50 mm	Pneumatic w/ B. Bearing (3,50 x 7)	15,00 kg	1	
59831	1,20 mm	Ø 32x 1,50 mm	Flat Free PU (3,50 x 7)	14,20 kg	1	



120L

YPR 3000 WHEELBARROWS



YPR 3000 EL ARABALARI / BROUETTE YPR 3000
3000YPR عربات / YPR 3000 Тачки



						
39321	1,20 mm	Ø 32 x 1,50 mm	Semi Solid w/ Bushing	17,30 kg	1	
39601	1,20 mm	Ø 32 x 1,50 mm	Semi Solid w/ B. Bearing	17,40 kg	1	
39101	1,20 mm	Ø 32 x 1,50 mm	Pneumatic w/ B. Bearing (3,50 x 7)	16,40 kg	1	
39121	1,20 mm	Ø 32 x 1,50 mm	Flat Free PU (3,50 x 7)	15,90 kg	1	
39201	1,20 mm	Ø 32 x 1,50 mm	Pneumatic w/ B. Bearing (3,50 x 8)	17,00 kg	1	

90L

YKS 80 WHEELBARROWS



YKS 80 EL ARABALARI / BROUETTE YKS 80
80 YKS عربات / YKS 80 Тачки



						
53321	0,80 mm	Ø 32 x 1,50 mm	Semi Solid w/ Bushing	12,35 kg	1	
53381	0,80 mm	Ø 32 x 1,50 mm	Semi Solid w/ B. Bearing	12,45 kg	1	
53121	0,80 mm	Ø 32 x 1,50 mm	Pneumatic w/ B. Bearing (3,50 x 7)	11,65 kg	1	
54911	0,80 mm	Ø 32 x 1,50 mm	Pneumatic w/ Plastic Rim (3,50 x 7)	11,85 kg	1	
54921	0,80 mm	Ø 32 x 1,50 mm	Flat Free PU (3,50 x 7)	11,05 kg	1	

120L

YKS 3.80 WHEELBARROWS



YKS 3.80 EL ARABALARI / BROUETTE YKS 3.80
3,80 YKS عربات / YKS 3.80 Тачки



						
32331	0,80 mm	Ø 32 x 1,50 mm	Semi Solid w/ Bushing	14,20 kg	1	
32611	0,80 mm	Ø 32 x 1,50 mm	Semi Solid w/ B. Bearing	14,30 kg	1	
33611	0,80 mm	Ø 32 x 1,50 mm	Pneumatic w/ B. Bearing (3,50 X 7)	12,85 kg	1	
34661	0,80 mm	Ø 32 x 1,50 mm	Flat Free PU (3,50 x 7)	12,70 kg	1	
35611	0,80 mm	Ø 32 x 1,50 mm	Pneumatic w/ B. Bearing (3,50 X 8)	13,56 kg	1	

120L

YKS 3.120 WHEELBARROWS



YKS 3.120 EL ARABALARI / BROUETTE YKS 3.120
3.120 YKS عربات فوزا / YKS 3.120 тачки



32361	1,20 mm	Ø 32 x 2,00 mm	Semi Solid w/ Bushing	18,35 kg	1
32641	1,20 mm	Ø 32 x 2,00 mm	Semi Solid w/ B. Bearing	18,45 kg	1
33641	1,20 mm	Ø 32 x 2,00 mm	Pneumatic w/ B. Bearing (3,50 x 7)	17,20 kg	1
33661	1,20 mm	Ø 32 x 2,00 mm	Flat Free PU (3,50 x 7)	16,00 kg	1
35641	1,20 mm	Ø 32 x 2,00 mm	Pneumatic w/ B. Bearing (3,50 x 8)	18,00 kg	1

80L

FUZE WHEELBARROWS



FUZE EL ARABALARI / BROUETTE FUZE
FUZE عربات فوزا اليدوية / FUZE тачки



55371	0,60 mm	Ø 32x1,00 mm	Semi Solid w/ Bushing	9,40 kg	1
55511	0,60 mm	Ø 32x1,00 mm	Pneumatic w/ B. Bearing (3,50 x 7)	8,50 kg	1

80L

FUZE WHEELBARROWS METAL LEG



FUZE EL ARABASI SAC AYAK / BROUETTE FUZE 70 (JAMBE EN MÉTAL)
FUZE عربات فوزا 70 (القدم المعدنية) / FUZE тачки (металлическая ножка)



51751	0,60 mm	Ø 32x1,00 mm	Semi Solid w/ Bushing	10,20 kg	1
51451	0,60 mm	Ø 32x1,00 mm	Pneumatic w/ B. Bearing (3,50 x 7)	9,20 kg	1

80L

FUZE 70 WHEELBARROWS



FUZE 70 EL ARABALARI / BROUETTE FUZE 70
FUZE 70 عربات فوزا اليدوية / FUZE 70 тачки







55361	0,70 mm	Ø 32x1,00 mm	Semi Solid w/ Bushing	10,00 kg	1
55781	0,70 mm	Ø 32x1,00 mm	Pneumatic w/ B. Bearing (3,50 x 7)	9,00 kg	1

YAPAR GREENHOUSE WHEELBARROWS

YAPAR SERA EL ARABALARI / YAPAR BROUETTE POUR SERRE
عربات يابار للحمامات الزراعية / YAPAR Тачка парника







	axb				
54801	530x740 mm	Ø 32 x 1,50 mm	Pneumatic w/ B. Bearing (3,50 x 7)	14,00 kg	1

FUZE GREENHOUSE WHEELBARROWS

FUZE SERA EL ARABALARI / FUZE BROUETTE POUR SERRE
عربات فوزا للحمامات الزراعية / FUZE тачка парника



	axb				
55801	530x720 mm	Ø 32x1,50 mm	Pneumatic w/ B. Bearing (3,50 x 7)	12,40 kg	1





DEMONTABLE WHEELBARROWS

Demonte El Arabaları Brouette Demonté

العربات اليدوية القابلة لل فك

Демонтируемые Тачки

Leaping forward to increase the product range in accordance with the changing sense of trade and shipment, and requests of international markets, YAPARLAR started production of disassembled wheelbarrows that requires a wider machine park and sensitive production assembled by the end user.

Değişen ticaret ve nakliye anlayışı ile dış pazarlardan gelen talepler doğrultusunda üretim çeşitliliğini artırmak için atılımda bulunan YAPARLAR, daha geniş makine parkı ve hassas imalat gerektiren, montajının nihai tüketici tarafından yapılacağı demonte el arabaları imalatına başlamıştır.



YAPARLAR qui plonge pour augmenter la diversité des produits en ligne avec demandes intérieurs et extérieurs vec la compréhension de commerce et de transport qui change, à commencé de produire des brouettes demontés, qui exige la précision de fabrication et un parque de machine plus grande et qui sera montagé par le consommateur final.

Yaparlara yangin yangin anaplanı ve ticaretin deňişen anlayışı ile diř pazarlardan gelen talepler dođrultusunda üretim çeřitliliđini artırmak için atılımda bulunan YAPARLAR, daha geniř makine parkı ve hassas imalat gerektiren, montajının nihai tüketicisi tarafından yapılacağı demonte el arabaları imalatına bařlamıřtır.

Стремясь увеличить ассортимент продукции в соответствии с меняющимся смыслом торговли и отгрузки, а также запросами международных рынков, YAPARLAR начала производство разобранных тачек, то требует более широкого машинного парка и чувствительного производства, собранного конечным потребителем.

SHIPMENT INFORMATION

Nakliye Bilgisi

20' DC	40' HC	Jumbo Truck Tır
		
600 pcs./Adet	1320 pcs./Adet	1500 pcs./Adet

Bulk Loading / Yığıma Yükleme

700 pcs./Adet	1800 pcs./Adet	2000 pcs./Adet
---------------	----------------	----------------



Code / Kod / Code / Код

الرمز



Tekne Sac Kalınlığı / Tray Thickness / Caisse épaisseur / Толщина Лотка

سمك جدار الحوض



Chassis / Şasi / Châssis / Шасси

الهيكل



Wheel Type / Tekerlek Tipi / Type de Roue / Тип Колеса

نوع العجلة



Weight / Ağırlık / Poids / Вес

الوزن



Bundle Qty. / Bağ Adedi / Botte Quantité / Количество Пачки

عدد الربطة

90L

YAPAR 120 DEMONTABLE WHEELBARROWS



YAPAR 120 DEMONTE EL ARABALARI / YAPAR 120 BROUETTES DÉMONTABLES
قابلية للفك 120 عربات يابار / YAPAR 120 демонтируемые тачки



↔	🍲	~	⊙	📦	⊞
72131	1,20 mm	Ø 32x2,00 mm	Semi Solid w/ Bushing	16,25 kg	60
72231	1,20 mm	Ø 32x2,00 mm	Semi Solid w/ B. Bearing	16,35 kg	60
73131	1,20 mm	Ø 32x2,00 mm	Pneumatic w/ Bushing (3,50 x 7)	14,90 kg	60
73231	1,20 mm	Ø 32x2,00 mm	Pneumatic w/ B. Bearing (3,50 x 7)	15,10 kg	60
74331	1,20 mm	Ø 32x2,00 mm	Pneumatic w/ Plastic Rim (3,50 x 7)	15,45 kg	60

90L

YAPAR G120 DEMONTABLE WHEELBARROWS



YAPAR G120 DEMONTE EL ARABALARI / YAPAR G120 BROUETTES DÉMONTABLES
قابلية للفك G-120 عربات يابار / YAPAR G120 демонтируемые тачки



↔	🍲	~	⊙	📦	⊞
72139	1,20 mm	Ø 32x2,00 mm	Semi Solid w/ Bushing	16,25 kg	60
72239	1,20 mm	Ø 32x2,00 mm	Semi Solid w/ B. Bearing	16,35 kg	60
73139	1,20 mm	Ø 32x2,00 mm	Pneumatic w/ Bushing (3,50 x 7)	14,90 kg	60
73239	1,20 mm	Ø 32x2,00 mm	Pneumatic w/ B. Bearing (3,50 x 7)	15,10 kg	60
74339	1,20 mm	Ø 32x2,00 mm	Pneumatic w/ Plastic Rim (3,50 x 7)	15,45 kg	60





90L

YPR 120 DEMONTABLE WHEELBARROWS



YPR 120 DEMONTE EL ARABALARI / YPR 120 BROUETTES DÉMONTABLES
 120 YPR عربات قابلة للتركيب / YPR 120 демонтируемые тачки



↔					
72421	1,20 mm	Ø 32x1,50 mm	Semi Solid w/ Bushing	14,45 kg	60
73461	1,20 mm	Ø 32x1,50 mm	Pneumatic w/ B. Bearing (3,50 x 7)	13,75 kg	60





90L

YAPAR 100 DEMONTABLE WHEELBARROWS



YAPAR 100 DEMONTE EL ARABALARI / YAPAR 100 BROUETTES DÉMONTABLES
 100 YAPAR عربات قابلة للتركيب / YAPAR 100 демонтируемые тачки



↔					
72121	1,00 mm	Ø 32x2,00 mm	Semi Solid w/ Bushing	15,45 kg	60
72221	1,00 mm	Ø 32x2,00 mm	Semi Solid w/ B. Bearing	15,55 kg	60
73121	1,00 mm	Ø 32x2,00 mm	Pneumatic w/ Bushing (3,50 x 7)	14,10 kg	60
73221	1,00 mm	Ø 32x2,00 mm	Pneumatic w/ B. Bearing (3,50 x 7)	14,30 kg	60
74221	1,00 mm	Ø 32x2,00 mm	Pneumatic w/ Plastic Rim (3,50 x 7)	14,65 kg	60





90L

YPR G120 DEMONTABLE WHEELBARROWS



YPR G120 DEMONTE EL ARABALARI / YPR G120 BROUETTES DÉMONTABLES
 G120 YPR عربات قابلة للتركيب / YPR G120 демонтируемые тачки



↔					
72429	1,20 mm	Ø 32x1,50 mm	Semi Solid w/ Bushing	14,30 kg	60
73469	1,20 mm	Ø 32x1,50 mm	Pneumatic w/ B. Bearing (3,50 x 7)	13,60 kg	60





90L

YAPAR G100 DEMONTABLE WHEELBARROWS



YAPAR G100 DEMONTE EL ARABALARI / YAPAR G100 BROUETTES DÉMONTABLES
 G 100 YAPAR عربات قابلة للتركيب / YAPAR G100 демонтируемые тачки



↔					
72129	1,00 mm	Ø 32x2,00 mm	Semi Solid w/ Bushing	15,45 kg	60
72229	1,00 mm	Ø 32x2,00 mm	Semi Solid w/ B. Bearing	15,55 kg	60
73129	1,00 mm	Ø 32x2,00 mm	Pneumatic w/ Bushing (3,50 x 7)	14,10 kg	60
73229	1,00 mm	Ø 32x2,00 mm	Pneumatic w/ B. Bearing (3,50 x 7)	14,30 kg	60
74229	1,00 mm	Ø 32x2,00 mm	Pneumatic w/ Plastic Rim (3,50 x 7)	14,65 kg	60

90L

YPR 100 DEMONTABLE WHEELBARROWS



YPR 100 DEMONTE EL ARABALARI / YPR 100 BROUETTES DÉMONTABLES
 قابلة للفك 100 YPR عربات / YPR 100 демонтируемые тачки



↔	🍽️	~	🌀	📦	📏
72411	1,00 mm	Ø 32x1,50 mm	Semi Solid w/ Bushing	13,40 kg	60
73451	1,00 mm	Ø 32x1,50 mm	Pneumatic w/ B. Bearing (3,50x7)	12,70 kg	60

90L

YPR 80 DEMONTABLE WHEELBARROWS



YPR 80 DEMONTE EL ARABALARI / YPR 80 BROUETTES DÉMONTABLES
 قابلة للفك 80 YPR عربات / YPR 80 демонтируемые тачки



↔	🍽️	~	🌀	📦	📏
72401	0,80 mm	Ø 32x1,50 mm	Semi Solid w/ Bushing	12,55 kg	60
73441	0,80 mm	Ø 32x1,50 mm	Pneumatic w/ B. Bearing (3,50x7)	11,85 kg	60

90L

YPR G100 DEMONTABLE WHEELBARROWS



YPR G100 DEMONTE EL ARABALARI / YPR G100 BROUETTES DÉMONTABLES
 قابلة للفك G100 YPR عربات / YPR G100 демонтируемые тачки



↔	🍽️	~	🌀	📦	📏
72419	1,00 mm	Ø 32x1,50 mm	Semi Solid w/ Bushing	13,25 kg	60
73459	1,00 mm	Ø 32x1,50 mm	Pneumatic w/ B. Bearing (3,50x7)	12,55 kg	60

90L

YPR G80 DEMONTABLE WHEELBARROWS



YPR G80 DEMONTE EL ARABALARI / YPR G80 BROUETTES DÉMONTABLES
 قابلة للفك G80 YPR عربات / YPR G80 демонтируемые тачки



↔	🍽️	~	🌀	📦	📏
72409	0,80 mm	Ø 32x1,50 mm	Semi Solid w/ Bushing	12,40 kg	60
73449	0,80 mm	Ø 32x1,50 mm	Pneumatic w/ B. Bearing (3,50x7)	11,70 kg	60





80L

FUZE 80 DEMONTABLE WHEELBARROWS

FUZE

FÜZE 80 DEMONTE EL ARABALARI / FÜZE 80 BROUETTES DÉMONTABLES
عربات فوزا 80 اليدوية القابلة للنفك / FÜZE 80 демонтируемые тачки



					
72351	0,80 mm	Ø 32x1,20 mm	Semi Solid w/ Bushing	11,65 kg	60
73361	0,80 mm	Ø 32x1,20 mm	Pneumatic w/ B. Bearing (3,50x7)	10,55 kg	60
72352	0,80 mm	Ø 32x1,00 mm	Semi Solid w/ Bushing	11,45 kg	60
73362	0,80 mm	Ø 32x1,00 mm	Pneumatic w/ B. Bearing (3,50x7)	10,50 kg	60





80L

FUZE DEMONTABLE WHEELBARROWS

FUZE

FÜZE DEMONTE EL ARABALARI / FÜZE BROUETTES DÉMONTABLES
عربات فوزا اليدوية القابلة للنفك / FÜZE демонтируемые тачки



					
71321	0,60 mm	Ø 32x1,00 mm	Semi Solid w/ Bushing	10,60 kg	60
71331	0,60 mm	Ø 32x1,00 mm	Pneumatic w/ B. Bearing (3,50x7)	9,65 kg	60





80L

FUZE 70 DEMONTABLE WHEELBARROWS

FUZE

FÜZE 70 DEMONTE EL ARABALARI / FÜZE 70 BROUETTES DÉMONTABLES
عربات فوزا 70 اليدوية القابلة للنفك / FÜZE 70 демонтируемые тачки



					
72321	0,70 mm	Ø 32x1,20 mm	Semi Solid w/ Bushing	11,30 kg	60
73331	0,70 mm	Ø 32x1,20 mm	Pneumatic w/ B. Bearing (3,50x7)	10,90 kg	60
72322	0,70 mm	Ø 32x1,00 mm	Semi Solid w/ Bushing	11,05 kg	60
73332	0,70 mm	Ø 32x1,00 mm	Pneumatic w/ B. Bearing (3,50x7)	10,10 kg	60





80L

FUZE ECO DEMONTABLE WHEELBARROWS

FUZE

FÜZE EKO DEMONTE EL ARABALARI / FÜZE EKO BROUETTES DÉMONTABLES
عربات فوزا ايكو اليدوية القابلة للنفك / FÜZE EKO демонтируемые тачки







					
72161	0,70 mm	Ø 32x1,20 mm	Semi Solid w/ Bushing	10,85 kg	60
73261	0,70 mm	Ø 32x1,20 mm	Pneumatic w/ B. Bearing (3,50x7)	9,75 kg	60
71161	0,60 mm	Ø 32x1,20 mm	Semi Solid w/ Bushing	10,50 kg	60
71261	0,60 mm	Ø 32x1,20 mm	Pneumatic w/ B. Bearing (3,50x7)	9,55 kg	60

120L

YAPAR 3.120 DEMONTABLE WHEELBARROWS 

YAPAR 3.120 DEMONTE / YAPAR 3.120 BROUETTES DÉMONTABLES
قابلة للفك 3.120 عربات يابار / YAPAR 3.120 демонтируемые тачки







					
32401	1,20 mm	Ø 32x2,00 mm	Semi Solid w/ Bushing	17,75 kg	50
32681	1,20 mm	Ø 32x2,00 mm	Semi Solid w/ B. Bearing	17,85 kg	50
33401	1,20 mm	Ø 32x2,00 mm	Pneumatic w/ Bushing (3,50 x 7)	16,40 kg	50
33681	1,20 mm	Ø 32x2,00 mm	Pneumatic w/ B. Bearing (3,50 x 7)	16,60 kg	50
34681	1,20 mm	Ø 32x2,00 mm	Pneumatic w/ Plastic Rim (3,50 x 7)	16,95 kg	50
35681	1,20 mm	Ø 32x2,00 mm	Pneumatic w/ B. Bearing (3,50 x 8)	17,42 kg	50

120L

YPR 3.120 DEMONTABLE WHEELBARROWS 

YPR 3.120 DEMONTE EL ARABALARI / YPR 3.120 BROUETTES DÉMONTABLES
قابلة للفك 3.120 YPR عربات / YPR 3.120 демонтируемые тачки







					
32561	1,20 mm	Ø 32x1,50 mm	Semi Solid w/ Bushing	15,60 kg	50
33841	1,20 mm	Ø 32x1,50 mm	Pneumatic w/ B. Bearing (3,50 x 7)	14,90 kg	50
35841	1,20 mm	Ø 32x1,50 mm	Pneumatic w/ B. Bearing (3,50 x 8)	15,00 kg	50

120L

YAPAR G3.120 DEMONTABLE WHEELBARROWS 

YAPAR G3.120 DEMONTE EL ARABALARI / YAPAR G3.120 BROUETTES DÉMONTABLES
قابلة للفك G 3.120 عربات يابار / YAPAR G3.120 демонтируемые тачки







					
32409	1,20 mm	Ø 32x2,00 mm	Semi Solid w/ Bushing	17,75 kg	50
32689	1,20 mm	Ø 32x2,00 mm	Semi Solid w/ B. Bearing	17,85 kg	50
33409	1,20 mm	Ø 32x2,00 mm	Pneumatic w/ Bushing (3,50 x 7)	16,40 kg	50
33689	1,20 mm	Ø 32x2,00 mm	Pneumatic w/ B. Bearing (3,50 x 7)	16,60 kg	50
34689	1,20 mm	Ø 32x2,00 mm	Pneumatic w/ Plastic Rim (3,50 x 7)	16,95 kg	50
35689	1,20 mm	Ø 32x2,00 mm	Pneumatic w/ B. Bearing (3,50 x 8)	17,42 kg	50

120L

YPR G3.120 DEMONTABLE WHEELBARROWS 

YPR G3.120 DEMONTE EL ARABALARI / YPR G3.120 BROUETTES DÉMONTABLES
قابلة للفك G3.120 YPR عربات / YPR G3.120 демонтируемые тачки







					
32569	1,20 mm	Ø 32x1,50 mm	Semi Solid w/ Bushing	15,40 kg	50
33849	1,20 mm	Ø 32x1,50 mm	Pneumatic w/ B. Bearing (3,50 x 7)	14,70 kg	50
35849	1,20 mm	Ø 32x1,50 mm	Pneumatic w/ B. Bearing (3,50 x 8)	14,80 kg	50

120L

YAPAR 3.100 DEMONTABLE WHEELBARROWS

YAPAR 3.100 DEMONTE EL ARABALARI / YAPAR 3.100 BROUETTES DÉMONTABLES
قابلة للفك 3.100 يابار عربات / YAPAR 3.100 демонтируемые тачки







					
32391	1,00 mm	Ø 32x2,00 mm	Semi Solid w/ Bushing	16,95 kg	50
32671	1,00 mm	Ø 32x2,00 mm	Semi Solid w/ B. Bearing	16,96 kg	50
33391	1,00 mm	Ø 32x2,00 mm	Pneumatic w/ Bushing (3,50 x 7)	15,55 kg	50
33671	1,00 mm	Ø 32x2,00 mm	Pneumatic w/ B. Bearing (3,50 x 7)	15,65 kg	50
34771	1,00 mm	Ø 32x2,00 mm	Pneumatic w/ Plastic Rim (3,50 x 7)	15,35 kg	50
35631	1,00 mm	Ø 32x2,00 mm	Pneumatic w/ B. Bearing (3,50 x 8)	14,85 kg	50

120L

YPR 3.100 DEMONTABLE WHEELBARROWS

YPR 3.100 DEMONTE EL ARABALARI / YPR 3.100 BROUETTES DÉMONTABLES
قابلة للفك 3.100 YPR عربات / YPR 3.100 демонтируемые тачки







					
32551	1,00 mm	Ø 32x1,50 mm	Semi Solid w/ Bushing	14,50 kg	50
33831	1,00 mm	Ø 32x1,50 mm	Pneumatic w/ B. Bearing (3,50 x 7)	13,80 kg	50
35831	1,00 mm	Ø 32x1,50 mm	Pneumatic w/ B. Bearing (3,50 x 8)	13,90 kg	50

120L

YAPAR G3.100 DEMONTABLE WHEELBARROWS

YAPAR G3.100 DEMONTE EL ARABALARI / YAPAR G3.100 BROUETTES DÉMONTABLES
G 3.100 يابار عربات / YAPAR G3.100 демонтируемые тачки







					
32399	1,00 mm	Ø 32x2,00 mm	Semi Solid w/ Bushing	16,95 kg	50
32679	1,00 mm	Ø 32x2,00 mm	Semi Solid w/ B. Bearing	16,96 kg	50
33399	1,00 mm	Ø 32x2,00 mm	Pneumatic w/ Bushing (3,50 x 7)	15,55 kg	50
33679	1,00 mm	Ø 32x2,00 mm	Pneumatic w/ B. Bearing (3,50 x 7)	15,65 kg	50
34679	1,00 mm	Ø 32x2,00 mm	Pneumatic w/ Plastic Rim (3,50 x 7)	15,35 kg	50
35639	1,00 mm	Ø 32x2,00 mm	Pneumatic w/ B. Bearing (3,50 x 8)	14,85 kg	50

120L

YPR G3.100 DEMONTABLE WHEELBARROWS

YPR G3.100 DEMONTE EL ARABALARI / YPR G3.100 BROUETTES DÉMONTABLES
G3.100 YPR عربات / YPR G3.100 демонтируемые тачки



					
32559	1,00 mm	Ø 32x1,50 mm	Semi Solid w/ Bushing	14,30 kg	50
33839	1,00 mm	Ø 32x1,50 mm	Pneumatic w/ B. Bearing (3,50 x 7)	13,60 kg	50
35839	1,00 mm	Ø 32x1,50 mm	Pneumatic w/ B. Bearing (3,50 x 8)	13,70 kg	50

120L

YPR 3.80 DEMONTABLE WHEELBARROWS



YPR 3.80 DEMONTE EL ARABALARI / YPR 3.80 BROUETTES DÉMONTABLES
 3.80 YPR قابيلة للفك عربات / YPR 3.80 демонтируемые тачки



32531	0,80 mm	Ø 32x1,50 mm	Semi Solid w/ Bushing	13,45 kg	50
33811	0,80 mm	Ø 32x1,50 mm	Pneumatic w/ B. Bearing (3,50 x 7)	12,75 kg	50
35811	0,80 mm	Ø 32x1,50 mm	Pneumatic w/ B. Bearing (3,50 x 8)	12,85 kg	50

120L

YAPAR 3.120 DOUBLE WHEEL DEMONTABLE WHEELBARROW



YAPAR 3.120 ÇİFT TEKERLEKLİ DEMONTE EL ARABALAR
 YAPAR 3.120 BROUETTE À DEUX ROUES DÉMONTABLE
 عربات يابار 3.120 قابيلة للفك بعجلتين
 YAPAR 3.120 двухколесные демонтируемые тачки



37601	1,20 mm	Ø 32x2,00 mm	Pneumatic w/ B. Bearing (3,50 x 7)	18,90 kg	30

120L

YPR G3.80 DEMONTABLE WHEELBARROWS



YPR G3.80 DEMONTE EL ARABALARI / YPR G3.80 BROUETTES DÉMONTABLES
 3.80 YPR قابيلة للفك عربات / YPR G3.80 демонтируемые тачки



32539	0,80 mm	Ø 32x1,50 mm	Semi Solid w/ Bushing	13,25 kg	50
33819	0,80 mm	Ø 32x1,50 mm	Pneumatic w/ B. Bearing (3,50 x 7)	12,55 kg	50
35819	0,80 mm	Ø 32x1,50 mm	Pneumatic w/ B. Bearing (3,50 x 8)	12,60 kg	50

120L

YPR 3.80 DOUBLE WHEEL DEMONTABLE WHEELBARROW



YPR 3.80 ÇİFT TEKERLEKLİ DEMONTE EL ARABALARI / YPR 3.80 BROUETTE À DEUX ROUES DÉMONTABLE
 3.80 YPR قابيلة للفك ذو عجلتين / YPR 3.80 двухколесные демонтируемая тачка



37611	0,80 mm	Ø 32x1,50 mm	Pneumatic w/ B. Bearing (3,50 x 7)	15,25 kg	30



PACKAGING INFORMATION

Ambalaj Bilgisi

Crate Dimensions (mm) Sandık Boyutları (mm)	Quantity in Crate Sandıktaki Adet
1070 x 2250 x 1120	30 - 50 - 60 pcs./Adet

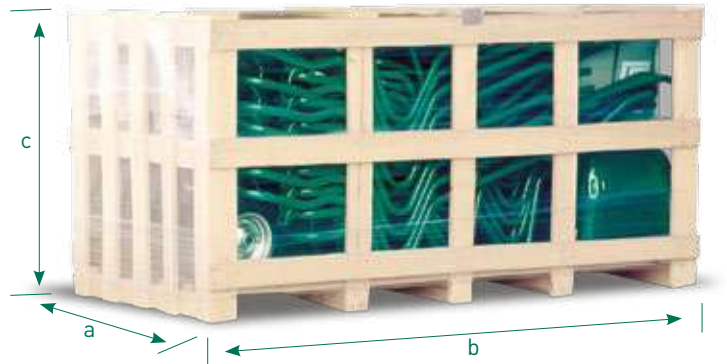
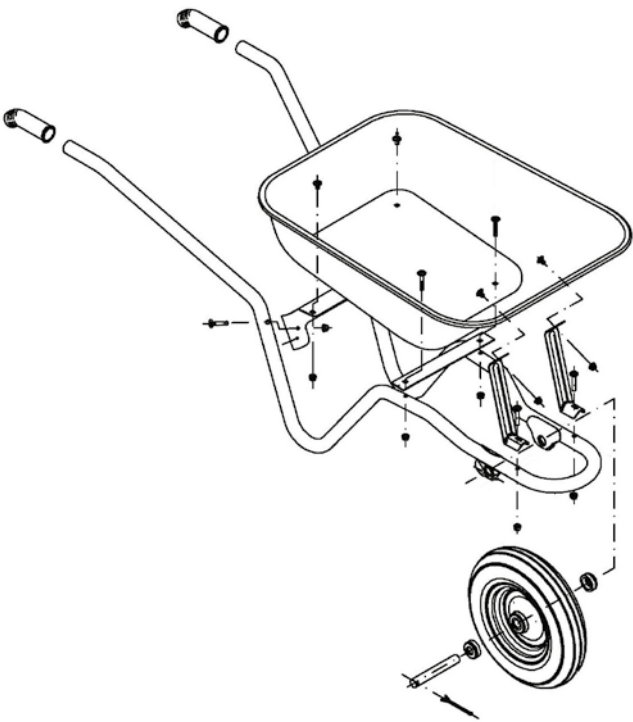



Code / Kod / Code / Код
الرمز



Chassis / Şasi / Châssis / Шасси
الهيكل



Wheel Type / Tekerlek Tipi / Type de Roue / Тип Колеса
نوع العجلة



Weight / Ağırlık / Poids / Вес
الوزن



Bundle Qty. / Bağ Adedi / Botte Quantité / Количество Пачки
عدد الربطة

120L

YPR 3000 PLASTIC WHEELBARROWS



YAPAR 3000 PLASTİK EL ARABALARI / BROUETTE EN PLASTIQUE YPR 3000
YPR 3000 عربات البلاستيك / YPR 3000 тачка пластиковый лоток



↔	~	⊙	⊞	≡
76111	32 x 1,50 mm	Semi Solid w/ Bushing	13,05 kg	1
76211	32 x 1,50 mm	Pneumatic w/ B. Bearing (3,50 x 7)	12,00 kg	1
76411	32 x 1,50 mm	Pneumatic w/ Plastic Rim (3,50 x 7)	11,80 kg	1
76511	32 x 1,50 mm	Flat Free PU (3,50 x 7)	11,90 kg	1
76611	32 x 1,50 mm	Pneumatic w/ B. Bearing (3,50 x 8)	12,45 kg	1

120L

YPR 3000 PLASTIC WHEELBARROWS METAL LEG



YAPAR 3000 PLASTİK EL ARABALARI SAC AYAKLI / BROUETTE EN PLASTIQUE YPR 3000
(القدم المعدنية) YPR 3000 عربات البلاستيك (YPR 3000 тачка пластиковый лоток (металлическая ножка)



↔	~	⊙	⊞	≡
77111	32 x 1,50 mm	Semi Solid w/ Bushing	14,25 kg	1
77211	32 x 1,50 mm	Pneumatic w/ B. Bearing (3,50 x 7)	13,20 kg	1
77411	32 x 1,50 mm	Pneumatic w/ Plastic Rim (3,50 x 7)	13,00 kg	1
77511	32 x 1,50 mm	Flat Free PU (3,50 x 7)	13,10 kg	1
77611	32 x 1,50 mm	Pneumatic w/ B. Bearing (3,50 x 8)	13,65 kg	1



240L

YPR 5000 PLASTIC WHEELBARROWS



YPR 5000 PLASTİK EL ARABALARI (DEVİRMELİ) / YPR 5000 BROUETTE EN PLASTIQUE À DEUX ROUES
 YPR 5000 عربات البلاستيك / YPR 5000 двухколесная пластиковая тачка



78611



32 x 2,00 mm



Pneumatic w/ B. Bearing (3,50 x 8)



25,90 kg



1



ZAHİRE KÜREĞİ (PLASTİK)
GRAIN SHOVEL (PLASTIC)

FÜZE

KOD: 9704



8 692828 97266 1

10 ADET / PCS



ZAHİRE KÜREĞİ (PLASTİK)
GRAIN SHOVEL (PLASTIC)

10
ADET / PCS

HAND TRUCKS

Koli Taşıma Arabası Diabiles

عربة نقل الامتعة
Ручные Тележки

Hand Trucks have original design and durable body. Carrying the precise quality understanding and meticulous manufacturing assurance of YAPARLAR, YAPAR and YPR brand Hand Trucks will provide convenience in transportation including stair climbing with Fixed Plate, Folding Plate and Acrobat models.

Koli Taşıma Arabaları, özgün tasarıma ve dayanıklı gövdeye sahiptir. YAPARLAR' ın hassas kalite anlayışı ve titiz imalat güvencesini taşıyan YAPAR ve YPR marka Koli Taşıma Arabaları, Sabit Tabla, Katlanır Tabla ve Akrobat modelleriyle merdiven çıkma dahil taşımada kolaylık sağlayacaklardır.

Les diables à main ont un design original et un corps durable. Grâce à la compréhension précise de la qualité et à l'assurance méticuleuse de la fabrication des diables à main de marque YAPARLAR, YAPAR et YPR, le transport sera pratique, y compris la montée d'escaliers avec des modèles à plaque fixe, plaque pliante et Acrobat.

شاحنات اليد لديها التصميم الأصلي وجسم دائم. توفر دقة فهم الجودة وضمان التصنيع الدقيق لشاحنات اليد ذات العلامات الراححة في النقل بما في YAPAR و YPR و YAPARLAR التجارية ذلك تسلق السلالم باستخدام نماذج اللوحات الثابتة ولوحة الطي وأكروبات

Ручные Тележки имеют оригинальный дизайн и прочный кузов. Точное понимание качества и тщательное обеспечение производства YAPARLAR, YAPAR и YPR бренд обеспечат удобство транспортировки, в том числе подъем по лестнице с фиксированной плитой, откидной плитой и моделями акробатов.





Code / Kod / Code / Код

الرمز

a x b x c

Dimensions / Ölçüler / Dimensions / Размеры

القياسات



Wheel Type / Tekerlek Tipi / Type de Roue / Тип Колеса

نوع العجلة



Plate Dimensions / Tabla Ölçüsü / Dimensions du plaque / Размер таблицы

أبعاد اللوحة



Weight / Ağırlık / Poids / Вес

الوزن



Bundle Qty. / Bağ Adedi / Botte Quantité / Количество Пачки

عدد الربطة

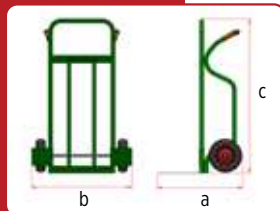

YAPAR HT500 HAND TRUCK



YAPAR HT500 KOLİ TAŞIMA ARABASI / DIABLES YAPAR HT500
HT500 قارورة لكون وعتمة / YAPAR HT500 ручная тележка



	a x b x c				
80501	60 x 72 x 115 cm	Solid w/Bushing (200x50)	34 x 50 cm	18,20 kg	1
80502	60 x 72 x 115 cm	Solid w/ Ball Bearing (200x50)	34 x 50 cm	18,70 kg	1
80506	60 x 72 x 115 cm	Solid w/Bushing(250x50)	34 x 50 cm	19,90 kg	1
80507	60 x 72 x 115 cm	Solid w/ Ball Bearing (250x50)	34 x 50 cm	20,65 kg	1
80503	60 x 72 x 115 cm	Solid w/ Plastic Rim (200x50)	34 x 50 cm	17,60 kg	1
80504	60 x 72 x 115 cm	Pneumatic (3,00 x 4)	34 x 50 cm	17,00 kg	1
80505	60 x 72 x 115 cm	3 Wheel Stair Climbing	34 x 50 cm	21,60 kg	1

YAPAR HT510 FOLDING HAND TRUCK



YAPAR HT510 KOLİ TAŞIMA ARABASI (KATLANIR) / DIABLES Pliable YAPAR HT510
HT510 قارورة لكون وعتمة / YAPAR HT510 ручная тележка (складная)



	a x b x c				
80511	60 x 72 x 115 cm	Solid w/Bushing (200x50)	34 x 50 cm	19,30 kg	1
80512	60 x 72 x 115 cm	Solid w/ Ball Bearing (200x50)	34 x 50 cm	19,80 kg	1
80516	60 x 72 x 115 cm	Solid w/Bushing (250x50)	34 x 50 cm	21,05 kg	1
80517	60 x 72 x 115 cm	Solid w/ Ball Bearing (250x50)	34 x 50 cm	21,75 kg	1
80513	60 x 72 x 115 cm	Solid w/ Plastic Rim (200x50)	34 x 50 cm	18,75 kg	1
80514	60 x 72 x 115 cm	Pneumatic (3,00 x 4)	34 x 50 cm	18,15 kg	1
80515	60 x 72 x 115 cm	3 Wheel Stair Climbing	34 x 50 cm	22,70 kg	1

YAPAR AKROBAT HAND TRUCK

YAPAR AKROBAT KOLİ TAŞIMA ARABASI / DIABLES YAPAR ACROBATE
AKROBAT عربیة نقل الامتعة / YAPAR ручная тележка акробата



↔	a x b x c				
80902	60 x 72 x 115 cm	Pneumatic (3,00 x 4)	34 x 50 cm	18,40 kg	1

YPR HT200 HAND TRUCK

YPR HT200 KOLİ TAŞIMA ARABASI / DIABLES YPR HT200
HT200 عربیة نقل الامتعة / YPR HT200 ручная тележка



↔	a x b x c				
80201	58 x 49 x 117 cm	Solid w/ Bushing (200x50)	32 x 48 cm	12,70 kg	1
80202	58 x 49 x 117 cm	Solid w/ Ball Bearing (200x50)	32 x 48 cm	13,22 kg	1
80203	58 x 49 x 117 cm	Solid w/ Plastic Rim (200x50)	32 x 48 cm	12,13 kg	1
80206	58 x 49 x 117 cm	Solid w/ Bushing (250x50)	32 x 48 cm	14,40 kg	1
80207	58 x 49 x 117 cm	Solid w/ Ball Bearing (250x50)	32 x 48 cm	15,18 kg	1
80204	58 x 49 x 117 cm	Pneumatic (3,00 x 4)	32 x 48 cm	11,55 kg	1
80205	58 x 49 x 117 cm	3 Wheel Stair Climbing	32 x 48 cm	16,10 kg	1

YPR HT210 FOLDING HAND TRUCK

YPR HT210 KOLİ TAŞIMA ARABASI (KATLANIR) / DIABLES PLIABLE YPR HT210
HT210 عربیة نقل الامتعة القابلة للطي / YPR HT210 ручная тележка (складная)







↔	a x b x c				
80211	58 x 49 x 117 cm	Solid w/ Bushing (200x50)	32 x 48 cm	13,55 kg	1
80212	58 x 49 x 117 cm	Solid w/ Ball Bearing (200x50)	32 x 48 cm	14,05 kg	1
80213	58 x 49 x 117 cm	Solid w/ Plastic Rim (200x50)	32 x 48 cm	12,95 kg	1
80216	58 x 49 x 117 cm	Solid w/ Bushing (250x50)	32 x 48 cm	15,25 kg	1
80217	58 x 49 x 117 cm	Solid w/ Ball Bearing (250x50)	32 x 48 cm	16,00 kg	1
80214	58 x 49 x 117 cm	Pneumatic (3,00 x 4)	32 x 48 cm	12,35 kg	1
80215	58 x 49 x 117 cm	3 Wheel Stair Climbing	32 x 48 cm	16,95 kg	1

YPR HT100 HAND TRUCK

YPR HT100 KOLİ TAŞIMA ARABASI / DIABLES YPR HT100
HT100 عربیة نقل الامتعة / YPR HT100 ручная тележка



↔	a x b x c				
80101	56 x 48 x 117 cm	Solid w/ Bushing (200x50)	30 x 47 cm	11,95 kg	1
80102	56 x 48 x 117 cm	Solid w/ Ball Bearing (200x50)	30 x 47 cm	12,45 kg	1
80103	56 x 48 x 117 cm	Solid w/ Plastic Rim (200x50)	30 x 47 cm	11,40 kg	1



WHEELS AND SPARES

Tekerlekler ve Yedekler
Roues et Rechanges

عجلات وقطع الغيار

Колеса И Запасные Части

YAPARLAR produces wheels and trays for wheelbarrows with tire, rim and bedding models suitable for different intended purposes to complement its product in line with customer needs.

YAPARLAR, tüketicinin ihtiyacı doğrultusunda ürününü tamamlayabilmesi için farklı kullanım amaçlarına uygun lastik, jant ve yataklama modelleri ile el arabaları için tekerlek ve tekne imalatı gerçekleştirmektedir.

YAPARLAR produit les roues et plateaux pour brouettes avec des modèles de pneus et jantes adaptés à des objectifs différents pour répondre aux besoins des clients.

تقوم يابارلار بتصنيع عجلات وصواني لل عربات اليدوية بإطار عجلة، جنط و نماذج تحميل مناسبة لأهداف الاستعمال المتنوعة من أجل إمكانية إكمال إنتاجها على ضوء حاجة المستهلك

YAPARLAR производит колеса и лотки для тачек с моделями шин, обода и подстилки, пригодными для различных целей, чтобы дополнить свой продукт в соответствии с потребностями клиентов.



Code / Kod / Code / Код

الرمز



Bushing Type / Yatak Tipi / Type De Roulement / Тип Втулки

نوع المسند



Outside Diameter / Dış Çap / Diamètre Extérieur / Наружный диаметр.

القطر الخارجي



Shaft Diameter / Mil Delik Çapı / Diamètre De Trou De L'axe / Диаметр вала.

طول فتحة العمود



Air Pressure / Şişirme Basıncı / Pression de l'air / Давление воздуха

ضغط الهواء



Max. Load / Maksimum Yük / Charge Maximale / Максимальная нагрузка

اقصى حمل



Weight / Ağırlık / Poids / Вес

الوزن



Bundle Qty. / Bağ Adedi / Botte Quantité / Количество Пачки

عدد الربطة

PNEUMATIC WHEEL 3,50x7



ŞİŞME TEKERLEK 3,50x7 / ROUE PNEUMATIQUE 3.50X7

عجلة قابلة للنفخ 3.50 x 7 / пневматическое колесо 3.50x7



Code	Bushing	Outside Diameter	Shaft Diameter	Max. Load	Air Pressure	Weight	Bundle Qty.
62211	Bushing	355 mm	20 mm	150 kg	20 PSI	2,15 kg	5
62221	Ball Bearing	355 mm	20 mm	150 kg	20 PSI	2,30 kg	5

PNEUMATIC WHEEL 3,50X7 (W/ BALL BEARING)



ŞİŞME TEKERLEK 3,50 x 7 (RULMANLI) / ROUE PNEUMATIQUE 3.50X7 AVEC AXE ROULEMENT À BILLE (بالرولمان) 3.50x7

عجلة قابلة للنفخ 3.50x7 (بالرولمان) / пневматическое колесо 3.50x7 (с шарикоподшипником)



Code	Bushing	Outside Diameter	Shaft Diameter	Max. Load	Air Pressure	Weight	Bundle Qty.
62824	Ball Bearing	355 mm	20 mm	120 kg	20 PSI	2,15 kg	5

PNEUMATIC WHEEL 3,50X7 W/ BALL BEARING



ŞİŞME TEKERLEK 3,50X7 (RULMANLI)

ROUE PNEUMATIQUE 3.50X7 AVEC AXE ROULEMENT À BILLE

عجلة قابلة للنفخ 3.50x7 (بالرولمان)

пневматическое колесо 3.50x7 с шарикоподшипником



Code	Bushing	Outside Diameter	Shaft Diameter	Max. Load	Air Pressure	Weight	Bundle Qty.
62121	Ball Bearing	355 mm	20 mm	100 kg	20 PSI	2,00 kg	5



PNEUMATIC WHEEL 3,50x7 (PLASTIC RIM)



ŞİŞME TEKERLEK 3,50x7 (PLASTİK JANTLI) / ROUE PNEUMATIQUE (PLASTIQUE) 3.50X7
 عجلة قابلة للنفخ (بايطار بلاستيك) 3.50 x 7
 пневматическое колесо 3.50x7 (пластиковый обод)



62326	Ball Bearing	355 mm	20 mm	150 kg	20 PSI	1,95 kg	5

FLAT FREE PU WHEEL 3,50x7



PATLAMAZ PU TEKERLEK 3,50x7 / ROUE INCREVABLE (3,50X7)
 عجلة رغوّة / полиуретановое колесо 3,50x7



65211	Bushing	330 mm	20 mm	100 kg	1,90 kg	5
65221	Ball Bearing	330 mm	20 mm	100 kg	2,05 kg	5

PNEUMATIC WHEEL 3,50x8



ŞİŞME TEKERLEK 3,50x8 / ROUE PNEUMATIQUE 3.50X8
 عجلة قابلة للنفخ 3.50 x 8
 пневматическое колесо 3.50x8



68221	Ball Bearing	355 mm	20 mm	150 kg	20 PSI	2,75 kg	5

PNEUMATIC WHEEL 3,50x8



ŞİŞME TEKERLEK 3,50x8 / ROUE PNEUMATIQUE 3.50X8
 عجلة قابلة للنفخ 3.50 x 8
 пневматическое колесо 3.50x8



68824	Ball Bearing	370 mm	20 mm	120 kg	20 PSI	2,45 kg	5

SEMI SOLID WHEEL



TÜP TEKERLEK / PNEU DE BROUETTE INCREVABLE
 عجلة انبوبية / твердое колесо



63211	Bushing	330 mm	20 mm	150 kg	3,20 kg	5
63221	Ball Bearing	330 mm	20 mm	150 kg	3,40 kg	5

SEMI SOLID WHEEL



TÜP TEKERLEK / PNEU DE BROUETTE INCREVABLE
 عجلة انبوبية / твердое колесо



63114	Bushing	330 mm	20 mm	100 kg	2,95 kg	5
63124	Ball Bearing	330 mm	20 mm	100 kg	3,20 kg	5

PNEUMATIC WHEEL 3,00x4 **YPR**

SİSME TEKERLEK 3,00x4 / ROUE PNEUMATIQUE 3.00X4
3.00 x 4 عجلة قابلة للنفخ / пневматическое колесо 3.00x4



69331	-	250 mm	20 mm	100 kg	20 PSI	0,95 kg	5

SOLID WHEEL (250x50) **YPR**

DOLGU TEKERLEK (250x50) / ROUE PLEINE (250X50)
250x50 عجلة صلبة / твердое колесо (250x50)



64112	Bushing	250 mm	20 mm	200 kg	2,40 kg	6
64122	Ball Bearing	250 mm	20 mm	250 kg	2,75 kg	6

SOLID WHEEL W/PLASTIC RIM (200x50) **YPR**

DOLGU TEKERLEK (200x50) PLASTİK JANTLI / ROUE PLEINE AVEC JANTE EN PLASTIQUE (200X50)
200x50 عجلة صلبة مع فلاح فيليكيتس لابل / твердое колесо с пластиковым ободом (200x50)



64331	-	200 mm	20 mm	200 kg	1,26 kg	6

SOLID WHEEL (200x50) **YPR**

DOLGU TEKERLEK (200x50) / ROUE PLEINE (200X50)
200x50 عجلة صلبة / твердое колесо (200x50)



64111	Bushing	200 mm	20 mm	200 kg	1,54 kg	6
64121	Ball Bearing	200 mm	20 mm	200 kg	1,79 kg	6

SOLID WHEEL (150x45) **YPR**

DOLGU TEKERLEK (150x45) / ROUE PLEINE (150X45)
150x45 عجلة صلبة / твердое колесо (150x45)



64411	Bushing	150 mm	20 mm	150 kg	0,78 kg	10

3 WHEEL SET (STAIR CLIMBING) **YPR**

MERDİVEN ÇIKAN TEKERLEK SETİ / ROUES D'ESCALADE D'ESCALIER
3 عجلة قلمست ردلاج / набор колес лестничного подъемника



64510	Bushing	3x(150x45)	20 mm	300 kg	3,25 kg	2



TYRE **YAPAR**

DIŞ LASTİK / PNEU DE BROUETTE
المطاط الخارجي / покрышка



↔	⊙	⊞	≡
62766	3,50 x 7	0,95 kg	20
68766	3,50 x 8	1,12 kg	20

INNER TUBE **YAPAR**

İÇ LASTİK / CHAMBRE À AIR POUR PNEU DE BROUETTE
المطاط الداخلي / внутренняя труба



↔	⊙	⊞	≡
62666	3,50 x 7	0,30 kg	50
68666	3,50 x 8	0,33 kg	50

SHAFT WITH BALL BEARING **YAPAR**

MİL TAKIMI (Rulmanlı) / AXE ROULEMENT À BILLE
طقم عمود (بالرولمان) / вал с шарикоподшипником



↔	⊞	≡
67526	0,36 kg	1

SHAFT WITH BUSHING **YAPAR**

MİL TAKIMI (BURÇLU) / AXE ROULEMENT À ROULEAUX
طقم العمود (عادي) / вал с втулкой



↔	⊞	≡
67516	0,22 kg	1

SHAFT **YAPAR**

TEKERLEK MİLİ / AXE
عمود العجلة / вал



↔	⊙	⊞	≡
67566	Shaft	0,15 kg	1
67506	Set Shaft - Bold - Nut	0,09 kg	6



Code / Kod / Code / Код

الرمز



Thickness / Kalınlık / Epaisseur / Толщина

السماكة



Volume / Hacim / Объем

حجم



Weight / Ağırlık / Poids / Вес

الوزن







Bundle Qty. / Bağ Adedi / Botte Quantité / Количество Пачки

عدد الربطة

WHEELBARROW TRAY 

EL ARABASI TEKNESİ / PLATEAU DE BROUETTE
حوض العربة اليدوية / лоток для тачки







				
98701	0,80 mm	60 L (Liquid)	4,25 kg	1
98751	0,80 mm	100 L (Liquid)	5,55 kg	1
98721	1,00 mm	60 L (Liquid)	5,25 kg	1
98771	1,00 mm	100 L (Liquid)	6,85 kg	1
98731	1,20 mm	60 L (Liquid)	6,30 kg	1
98781	1,20 mm	100 L (Liquid)	7,70 kg	1

DEMONTABLE WHEELBARROW TRAY 

DEMONTÉ EL ARABASI TEKNESİ / PLATEAU DE BROUETTE DÉMONTABLE
حوض العربة اليدوية القابلة للفك / демонтируемый лоток для тачки



				
98801	0,80 mm	60 L (Liquid)	4,20 kg	1
98901	0,80 mm	100 L (Liquid)	5,20 kg	1
98821	1,0 mm	60 L (Liquid)	5,15 kg	1
98921	1,0 mm	100 L (Liquid)	6,40 kg	1
98831	1,20 mm	60 L (Liquid)	6,15 kg	1
98931	1,20 mm	100 L (Liquid)	7,70 kg	1



WHEELBARROW TRAY (GALVANIZED)



EL ARABASI TEKNESİ (GALVANİZLİ) / PLATEAU DE BROUETTE (GALVANISÉ)
(مغلفن) حوض العربة اليدوية / лоток для тачки (оцинкованный)



↔	🍲	📏	🔒	🔧
98709	0,80 mm	60 L (Liquid)	4,05 kg	1
98759	0,80 mm	100 L (Liquid)	5,22 kg	1
98729	1,00 mm	60 L (Liquid)	4,95 kg	1
98779	1,00 mm	100 L (Liquid)	6,60 kg	1
98739	1,20 mm	60 L (Liquid)	5,95 kg	1
98789	1,20 mm	100 L (Liquid)	7,95 kg	1

DEMONTABLE WHEELBARROWS TRAY (GALVANIZED)



DEMONTE EL ARABASI TEKNESİ (GALVANİZLİ) / PLATEAU DE BROUETTE DÉMONTABLE (GALVANISÉ)
(مغلفن) حوض العربة اليدوية القابلة للفك / демонтируемый лоток для тачки (оцинкованный)



↔	🍲	📏	🔒	🔧
98809	0,80 mm	60 L (Liquid)	3,97 kg	1
98909	0,80 mm	100 L (Liquid)	5,12 kg	1
98829	1,00 mm	60 L (Liquid)	4,85 kg	1
98929	1,00 mm	100 L (Liquid)	6,30 kg	1
98839	1,20 mm	60 L (Liquid)	5,80 kg	1
98939	1,20 mm	100 L (Liquid)	7,80 kg	1

WHEELBARROW TRAY PLASTIC



PLASTİK EL ARABASI TEKNESİ / PLATEAU DE BROUETTE PLASTIQUE
(بلاستيك) حوض العربة اليدوية / лоток для тачки пластиковый



↔	📏	🔒	🔧
98910	100 L (Liquid)	4.30 kg	1

DEMONTABLE WHEELBARROW TRAY PLASTIC



DEMONTE EL ARABASI TEKNESİ PLASTİK / PLATEAU DE BROUETTE DÉMONTABLE PLASTIQUE
(بلاستيك) حوض العربة اليدوية قابلة للفك / демонтируемый лоток для тачки пластиковый



↔	📏	🔒	🔧
98920	100 L (Liquid)	4.30 kg	1



Ekstra Celik
T.M.
YAPAR
4160 INSAAT KUREGI

SHOVELS

Kürekler
Pelles
المجارف
ЛОПАТЫ

YAPARLAR shovels produced for the most difficult works, provides ease of use with its functional and ergonomic design. Weight tolerance of the shovels is $\pm 3\%$ and the material thickness is 0.05 mm.

En zorlu işler için üretilen YAPARLAR kürekleri; dayanıklı yapısı, fonksiyonel ve ergonomik dizaynıyla büyük bir kullanım kolaylığı sağlamaktadır. Küreklerin ağırlık toleransı $\pm 3\%$, malzeme kalınlık toleransı ise 0.05 mm'dir.

Les pelles de construction de YAPARLAR sont fabriquées pour les travaux les plus exigeants ; ils fournissent la facilité d'utilisation grâce à leurs formes fonctionnelles et ergonomiques. La tolérance de poids des pelles est de $\pm 3\%$, l'épaisseur du matériau est de 0.05 mm.

مجارف إنشاءات يابارلار المنتجة من أجل أشد الظروف قسوة، تؤمن سهولة استعمال كبير بتصميمها المريح و العملي و بنيتها المقاومة وزن تحمل المجارف هو $\pm 3\%$ وسمك المواد 0.05 مم.

YAPARLAR строительные лопаты, производимые для самых сложных работ, обеспечивают удобство использования благодаря своему функциональному и эргономичному дизайну. Допуск по массе лопат составляет $\pm 3\%$, а толщина материала - 0,05 мм.

S

Straight
Düz
مسطح
Droite
Прямой

C

Curved
Eğik
مانتل
Courbée
Изогнутый

DP

w/ Plastic "D" Grip
Plastik "D" Tutamaklı
ذو ممسك بلاستيک بشكل "D"
Manche avec poignée en plastique
Черенок с пластмассовой ручкой

DM

w/ Steel & Wood "D" Grip
Demir & Ağaç "D" Tutamaklı
ذو ممسك حديد او خشب بشكل "D"
Manche avec poignée en acier et en bois
Черенок со стальным и деревянным захватом

T

w/ "T" Grip
"T" Tutamaklı
ذو ممسك بشكل "T"
Manche avec poignée de type Barrel T
Черенок со спец.ручкой в форме "T"



Code / Kod / Code / Код
الرمز



Thickness / Kalınlık / Épaisseur / Толщина
السماكة



Dimensions / Ölçüler / Dimensions / Размеры
القياسات



Diameter / Çap / Diamètre / Диаметр
الدائرة قطر



Handle Type / Sap Tipi / Type De Manche / Тип Черенок
نوع المقبض



Weight / Ağırlık / Poids / Вес
الوزن



Bundle Qty. / Bağ Adedi / Botte Quantité / Количество Пачки
عدد الرابطة

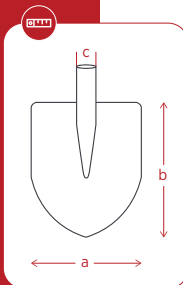

4160 CONSTRUCTION SHOVEL

4160 İNŞAAT KÜREĞİ / PELLE DE CHANTIER 4160
4160 جاروف البناء / 4160 строительная лопата



↔	→ ←	axb	∅			
11000	1,70 mm	255 x 280 mm	42 mm	1500 mm/C 1300 mm/C	0,95 kg	25

4160 PLUS CONSTRUCTION SHOVEL

4160 PLUS İNŞAAT KÜREĞİ / PELLE DE CHANTIER 4160 PLUS
4160 плюс строительная лопата



↔	→ ←	axb	∅			
19101	1,50 mm	255 x 280 mm	42 mm	1500 mm/C 1300 mm/C	0,88 kg	25

4160 VARNISHED CONSTRUCTION SHOVEL

4160 VERNİKLİ İNŞAAT KÜREĞİ / PELLE DE CHANTIER 4160 (VERNIE)
4160 ЛАКИРОВАННАЯ СТРОИТЕЛЬНАЯ ЛОПАТА







↔	→ ←	axb	∅			
11002	1,70 mm	255 x 280 mm	42 mm	1500 mm/C 1300 mm/C	0,95 kg	25



4160 - C CONSTRUCTION SHOVEL

4160 - C İNŞAAT KÜREĞİ / PELLE DE CHANTIER 4160-C
4160 C جاروف البناء / 4160-C Строительная Лопата

		axb	\emptyset			
19000	1,00 mm	255 x 280 mm	40 mm	1500 mm/C 1300mm/C	0,60 kg	25

4160-C construction shovel, which does not tire the user with its light structure, is long-lasting and durable with its special material suitable for high hardness. Its flexibility also provides advantages in use.

Hafif yapısıyla kullanıcıyı yormayan 4160-C inşaat küreği, yüksek sertliğe elverişli olan özel malzemesi ile uzun ömürlü ve dayanıklıdır. Esnekliği kullanımında ayrıca avantaj sağlar.

4160 - C CONSTRUCTION SHOVEL W/CURVED HANDLE

4160 - C İNŞAAT KÜREĞİ (EĞİK SAPLI) / 4160-C PELLE DE CHANTIER À MANCHE COURBÉE
(بعصا مائلة) C- 4160 جاروف البناء / 4160-C строительная лопата с изогнутым черенком







		axb	\emptyset			
19030	1,00 mm	255 x 280 mm	40 mm	1500 mm/C 1300 mm/C	2,20 kg	5

4160 CONSTRUCTION SHOVEL BLUE

4160 İNŞAAT KÜREĞİ MAVİ / PELLE DE CHANTIER (BLEU) 4160
4160 جاروف البناء ازرق / 4160 строительная лопата (синяя)



		axb	\emptyset			
18000	1,50 mm	255 x 280 mm	42 mm	1500 mm/C 1300 mm/C	0,86 kg	25

CONSTRUCTION SHOVEL NO 4

4 NO İNŞAAT KÜREĞİ / PELLE DE CHANTIER NUMÉRO 4
4 جاروف البناء رقم 4 / строительная лопата ном.4



		axb	\emptyset			
13000	1,50 mm	255 x 280 mm	42 mm	1500 mm/C 1300 mm/C	0,83 kg	25

CONSTRUCTION SHOVEL NO 4 FUZE

4 NO İNŞAAT KÜREĞİ / PELLE DE CHANTIER NO 4
4 جاروف البناء رقم 4 / строительная лопата ном:4



↔	→←	axb	∅	🔧	📦	📏
21000	1,50 mm	255 x 285 mm	42 mm	1500 mm/C 1300 mm/C	0,88 kg	25

CONSTRUCTION SHOVEL NO 4 DEMİR

DEMİR 4 NO İNŞAAT KÜREĞİ / PELLE DE CHANTIER NUMÉRO 4
4 جاروف البناء حديد رقم 4 / строительная лопата ном:4



↔	→←	axb	∅	🔧	📦	📏
21080	~1,50 mm	260 x 290 mm	42 mm	1500 mm/C 1300 mm/C	0,81 kg	25

5160 CONSTRUCTION SHOVEL YAPAR

5160 İNŞAAT KÜREĞİ / PELLE DE CHANTIER 5160
5160 جاروف البناء / 5160 строительная лопата



↔	→←	axb	∅	🔧	📦	📏
11100	1,70 mm	265 x 305 mm	42 mm	1500 mm/C 1300 mm/C	1,10 kg	25

5160 PLUS CONSTRUCTION SHOVEL W/1500 CURVED HANDLE YAPAR

5160 PLUS İNŞAAT KÜREĞİ (1500 EĞİK SAPLI) / PELLE DE CHANTIER 5160 AVEC MANCHE COURBÉE 1500
جاروف البناء 5160 بلس (1500 بعضا مائلة)
/ 5160 плюс строительная лопата с изогнутым черенком 1500



5160 PLUS CONSTRUCTION SHOVEL YAPAR

5160 PLUS İNŞAAT KÜREĞİ / PELLE DE CHANTIER 5160 PLUS
5160 PLUS جاروف البناء بلس / 5160 плюс строительная лопата







↔	→←	axb	∅	🔧	📦	📏
19201	1,50 mm	265 x 305 mm	42 mm	1500 mm/C 1300 mm/C	0,98 kg	25

↔	→←	axb	∅	🔧	📦	📏
19241	1,50 mm	265 x 305 mm	42 mm	1500 mm/C 1300 mm/C	2,18 kg	5



4150 SAND SHOVEL 

4150 KUM KÜREĞİ / PELLE À SABLE 4150
4150 جاروف الرمال / 4150 песчаная лопата

		axb	\emptyset			
11200	1,70 mm	250 x 275 mm	42 mm	1500 mm/C 1300 mm/C	0,98 kg	25

4150 Sand Shovel, whose design is suitable for transferring sand and soil, offers users a comfortable use for a long time with its hardened special steel and durable material.

Tasarımı kum ve toprak aktarmaya uygun olan 4150 Kum Küreği, sertleştirilmiş özel çeliği ve dayanıklı malzemesiyle, kullanıcılara uzun süre rahat bir kullanım sunmaktadır.

5150 SAND SHOVEL 

5150 KUM KÜREĞİ / PELLE À SABLE 5150
5150 جاروف الرمال / 5150 песчаная лопата



		axb	\emptyset			
11300	1,70 mm	265 x 295 mm	42 mm	1500 mm/C 1300 mm/C	1,10 kg	25

7160 SAND SHOVEL 

7160 KUM KÜREĞİ / PELLE À SABLE 7160
7160 جاروف الرمال / 7160 песчаная лопата



		axb	\emptyset			
11400	1,70 mm	285 x 310 mm	42 mm	1500 mm/C 1300 mm/C	1,20 kg	25

SQUARE SOIL SHOVEL 

DÜZ TOPRAK KÜREĞİ / PELLE CARRÉE
Düz Toprak Küreği / جاروف الرمال المسطح / квадратный лопаткоулавливатель почвы



		axb	\emptyset			
18100	1,70 mm	225 x 275 mm	38 mm	1500 mm/C 1300 mm/C	1,00 kg	10

SQUARE SOIL SHOVEL 

DÜZ TOPRAK KÜREĞİ / PELLE CARRÉE
Düz Toprak Küreği / جاروف الرمال المسطح / квадратный лопаткоулавливатель почвы



		axb	\emptyset			
28100	1,50 mm	225 x 275 mm	38 mm	1500 mm/C 1300 mm/C	0,90 kg	10



3200 SHARP POINTED SPADE **YAPAR**

3200 BEL KÜREĞİ (SIVRİ) / BÊCHE POINTUE 3200
(مدبب) جاروف الحدائق / 3200 острокопечная лопата

↔	→ ←	axb	∅	🍷	📦	⚡
14000	2,00 mm	225 x 290 mm	43 mm	1500 mm/S 1300 mm/S	1,00 kg	25

3200 Pointed Spade, which provides great advantage with its pointed tip and 2.00 mm thick special alloy steel, is the helper of the farmers in spring.

Sert toprakta kullanırken büyük avantaj sağlayan sivri ucu ve 2,00 mm kalınlıkta özel alaşım çeliğiyle 3200 Bel Küreği, toprak işleriyle uğraşan kullanıcıların bahar aylarında vaz geçemedikleri yardımcılarıdır.

3200 PLUS SHARP POINTED SPADE **YAPAR**

3200 PLUS BEL KÜREĞİ (SIVRİ) / BÊCHE POINTUE PLUS 3200
(مدبب) جاروف الحدائق 3200 بلص / 3200 плюс острокопечная лопата



↔	→ ←	axb	∅	🍷	📦	⚡
19301	1,70 mm	220 x 290 mm	43 mm	1500 mm/S 1300 mm/S	0,86 kg	25

3200 SHARP POINTED SPADE W/PRESS **YAPAR**

3200 BASKILI BEL KÜREĞİ (SIVRİ) / BÊCHE POINTUE À REBORD 3200
(مدبب) جاروف الحدائق 3200 نو مداس / 3200 острокопечная лопата с прессой



↔	→ ←	axb	∅	🍷	📦	⚡
14090	2,00 mm	225 x 370 mm	43 mm	1500 mm/S 1300 mm/S	1,30 kg	10

3200 SHARP POINTED SPADE **AYKS**

3200 BEL KÜREĞİ (SIVRİ) / BÊCHE POINTUE 3200
(مدبب) جاروف الحدائق 3200 / 3200 острокопечная лопата



↔	→ ←	axb	∅	🍷	📦	⚡
13200	1,70 mm	225 x 290 mm	43 mm	1500 mm/S	0,88 kg	25

POINTED SPADE **DEMİR**

DEMİR BEL KÜREĞİ / BÊCHE POINTUE
(مدبب) جاروف الحدائق حديد / острокопечная лопата



↔	→ ←	axb	∅	🍷	📦	⚡
24080	-2,00 mm	260 x 290 mm	43 mm	1500 mm/S 1300 mm/S	0,95 kg	25

3210 POINTED SPADE



3210 BEL KÜREGİ (AZ SIVRI) / BÊCHE POINTUE 3210
 جاروف الحدائق 3210 / جاروف الحدائق 3210 (مدبب قليل)
 острокопечная лопата 3210







		axb	\emptyset			
14100	2,00 mm	225 x 280 mm	43 mm	1500 mm/S 1300 mm/S	1,05 kg	25

3220 ROUND POINTED SPADE



3220 BEL KÜREGİ (YUVARLAK) / PELLE-BÊCHE 3220
 جاروف الحدائق 3220 (مدور) / جاروف الحدائق 3220
 круглая лопата пункта 3220



		axb	\emptyset			
14200	2,00 mm	225 x 280 mm	43 mm	1500 mm/S 1300 mm/S	1,05 kg	25

3170 RICE SHOVEL W/ PRESS (ROUND POINT)



3170 BASKILI ÇELTİK KÜREGİ (YUVARLAK) / PELLE À RIZ À REBORD 3170
 جاروف تشالتيك ذو مداس 3170 (مدوراغا خاص)
 / 3170 лопата рисовая с прессой (круглая острокопечная)



		axb	\emptyset			
17890	1,70 mm	215 x 320 mm	42 mm	1500 mm/S 1300 mm/S	0,82 kg	10

3170 RICE SHOVEL (ROUND POINT)



3170 ÇELTİK KÜREGİ (YUVARLAK) / PELLE À RIZ 3170
 جاروف تشالتيك ذو مداس 3170 (مدور) / 3170 рисовая лопата (круглая)



		axb	\emptyset			
14300	1,70 mm	225 x 255 mm	42 mm	1500 mm/S 1300 mm/S	0,85 kg	25

3190 RICE SHOVEL (POINTED)



3190 ÇELTİK KÜREGİ (SIVRI) / PELLE À RIZ POINTUE 3190
 جاروف تشالتيك ذو مداس 3190 (مدبب)
 / 3190 рисовая лопата (острокопечная)



		axb	\emptyset			
14400	1,70 mm	225 x 250 mm	42 mm	1500 mm/S 1300 mm/S	0,85 kg	25

3190 RICE SHOVEL W/PRESS (POINTED)



3190 BASKILI ÇELTİK KÜREGİ (SIVRI) / PELLE À RIZ À REBORD 3190 (POINTUE)
 جاروف تشالتيك ذو مداس 3190 (مدوراغا خاص)
 / 3190 лопата для риса с прессой (острокопечная)



		axb	\emptyset			
14490	1,70 mm	225 x 250 mm	42 mm	1500 mm/S 1300 mm/S	1,00 kg	10

4 TINE SPADING FORK



DÖRTLÜ ÇATAL BEL / FOURCHE À BÉCHER
شوكة حديقة ذو اربع اسنان / четырёхрогие вилы



↔	→←	axb	∅	🍷	📦	🌾
99070	6,00 mm	175 x285 mm	35 mm	675 mm/DM	2,00 kg	5

4170 FRANKFURT SHOVEL



4170 FRANKFURT KÜREĞİ/ PELLE ALSACIENNE 4170
جاروف فرانكفورتر / 4170 франкфуртская лопата



↔	→←	axb	∅	🍷	📦	🌾
14500	1,70 mm	255 x270 mm	42 mm	1500 mm/C 1300 mm/C	0,95 kg	25

4190 LOREN SHOVEL



4190 LOREN KÜREĞİ / PELLE LOREN 4190
جاروف الحدائق المسطح / 4190 лопата лорен



↔	→←	axb	∅	🍷	📦	🌾
14600	1,70 mm	240 x240 mm	42 mm	1500 mm/C 1300 mm/C	0,87 kg	25

7200 GRAIN SHOVEL



7200 ALÜMİNYUM ZAHİRE KÜREĞİ / PELLE À GRAIN 7200
جاروف الحبوب الالومنيوم / 7200 зерновая лопата



↔	→←	axb	∅	🍷	📦	🌾
83006	2,00 mm	360 x 420 mm	37 mm	1200 mm/S 700 mm/T	1,00 kg	5

Grain Shovels, which provide great convenience to the grain farmers and traders at harvest time, are designed with a large volume blade suitable for transferring and are produced from special alloy aluminum material with a thickness of 2.00 mm.

Hasat zamanı hububat çiftçisi ve tüccarına büyük kolaylık sağlayan Zahire Küreklere, taşımaya uygun şekilde geniş hacimli olarak tasarlanarak, 2,00 mm kalınlıkta özel alaşım alüminyum malzemeden üretilmektedirler.

7200 GRAIN SHOVEL W/DM HANDLE



7200 ZAHIRE KÜREĞİ (DM SAPLI) / PELLE À GRAINE 7200 AVEC MANCHE DM
(DM بعضا) 7200 جاروف الحبوب / 7200 зерновая лопата с черенком DM





↔	→ ←	axb	∅			
83056	2,00 mm	360 x 420 mm	37 mm	700 mm/DM	2,00 kg	5

4300 SQUARE MOUTH SHOVEL



4300 FARYAP KÜREĞİ / PELLE ANGLAISE CARRÉE 4300
4300 جاروف فاريب / 4300 лопата с квадратным ртом



↔	→ ←	axb	∅			
17000	1,70 mm	255 x 325 mm	38 mm	600 mm/DP/T	1,50 kg	5

SQUARE MOUTH SHOVEL NO 4



4 NO FARYAP KÜREĞİ / PELLE CARRÉE NUMÉRO 4
4 جاروف فاريب رقم 4 / лопата с квадратным ртом ном:4



↔	→ ←	axb	∅			
27000	1,50 mm	255 x 325 mm	38 mm	1200 mm/S 600 mm/S DM/DP/T	1,35kg	5

4300 SQUARE MOUTH SHOVEL W/DM HANDLE



4300 FARYAP KÜREĞİ (DM SAPLI) / PELLE ANGLAISE CARRÉE 4300 AVEC MANCHE DM
(DM بعضا) 4300 جاروف فاريب / 4300 лопата с квадратным ртом - с черенком DM



↔	→ ←	axb	∅			
17050	1,70 mm	255 x 325 mm	38 mm	600 mm/DM	2,40 kg	5

6300 SQUARE MOUTH SHOVEL 

6300 FARYAP KÜREGİ / PELLE ANGLAISE CARRÉE 6300
6300 جاروف فاريب / 6300 лопата с квадратным ртом





		axb	\emptyset			
17100	1,70 mm	280 x 350 mm	38 mm	600 mm/DP/T	1,70 kg	5

6300 SQUARE MOUTH SHOVEL W/DM HANDLE 

6300 FARYAP KÜREGİ (DM SAPLI) / PELLE ANGLAISE CARRÉE 6300 AVEC MANCHE DM
(DM بعصا) 6300 جاروف فاريب / 6300 квадратная лопата рта с черенком DM



		axb	\emptyset			
17150	1,70 mm	280 x 350 mm	38 mm	600 mm/DM	2,50 kg	5

6300 SQUARE MOUTH W/HANDLE 

6300 FARYAP KÜREGİ (DÜZ SAPLI) / PELLE ANGLAISE CARRÉE 6300 AVEC MANCHE DROITE
(بعصا مستوية) 6300 جاروف فاريب
6300 квадратных рот лопата с прямым черенком







		axb	\emptyset			
17110	1,70 mm	280 x 350 mm	38 mm	1200 mm/S	2,50 kg	5

SQUARE MOUTH SHOVEL NO 6 

6 NO FARYAP KÜREGİ / PELLE CARRÉE
6 جاروف فاريب رقم 6 / лопата с квадратным ртом ном:6







		axb	\emptyset			
27100	1,50 mm	280 x 350 mm	38 mm	1200 mm/S 600 mm/S DM/DP/T	1,50kg	5

SMALL SNOW SHOVEL (ALUMINIUM)



KÜÇÜK KAR KÜREĞİ (ALÜMİNYUM) / PETITE PELLE À NEIGE (ALUMINIUM)
 جاروف الثلج الومنيوم / маленькая лопата для снега (алюминиевая)



		axb	\emptyset			
83106	2,00 mm	265 x 300 mm	34 mm	T/DM/DP	0,50 kg	5

GALVANIZED PLASTERER SHOVEL



GALVANİZ SIVACI KÜREĞİ / PELLE À ORDURE GALVANISÉE
 جاروف القصار المغلفن / оцинкованная штукатур лопатой



		axb	\emptyset			
28104	1,20 mm	225 x 275 mm	38 mm	1500 mm/C 1300 mm/C	0,50 kg	10

PLASTERER SHOVEL



1150 SIVACI KÜREĞİ / PELLE À ORDURE 1150
 1150 جاروف القصار / 1150 лопата штукатур





		axb	\emptyset			
29410	1,20 mm	220 x 205 mm	26 mm	370 mm	0,50 kg	50

1250 COAL SHOVEL



1250 KÖMÜR KÜREĞİ / PELLE À CHARBON 1250
 1250 جاروف الفحم / 1250 угольная лопата



		axb	\emptyset			
29210	0,80 mm	175 x 255 mm	26 mm	370 mm	0,35 kg	40

1150 DUST SHOVEL



1150 ÇÖP KÜREĞİ / PELLE À ORDURE 1150
 1150 جاروف القمامة / 1150 лопата для мусора





		axb	\emptyset			
29010	0,80 mm	220 x 200 mm	26 mm	270 mm/S	0,35 kg	40

1200 STOVE SHOVEL



1200 SOBA KÜREĞİ / PELLE DE CHAUFFE 1200
 1200 جاروف المدفأة / 1200 плита лопата







		axb	\emptyset			
29110	0,80 mm	110 x 190 mm	26 mm	270 mm	0,25 kg	50

5200 MINER'S SHOVEL 

5200 MADENCİ KÜREĞİ / PELLE DE MINE 5200
5200 جاروف عامل المنجم / 5200 шахтерская лопата







		axb	∅			
17200	1,70 mm	270 x 315 mm	40 mm	1200 mm/S 1300 mm/S 600 mm/DP/T	1,35 kg	20

5210 MINER'S SHOVEL 

5210 MADENCİ KÜREĞİ / PELLE DE MINE 5210
5210 جاروف عامل المنجم / 5210 шахтерская лопата



		axb	∅			
17300	1,70 mm	260 x 320 mm	38 mm	1200 mm/S 1300 mm/S 600 mm/DP/T	1,25 kg	20

5210 MINER'S SHOVEL W/DP HANDLE 

5210 MADENCİ KÜREĞİ (DP SAPLI) / Pelle de mine 5210 avec manche DP
(DP بعضا) 5210 جاروف عامل المنجم / 5210 шахтерская лопата с черенком dp



		axb	∅			
17360	1,70 mm	260 x 320 mm	38 mm	600mm/DP	2,25 kg	5

5260 MINER'S SHOVEL 

5260 MADENCİ KÜREĞİ (OLUKLU) / PELLE DE MINE 5260
5260 جاروف عامل المنجم (مموج) 5260 шахтерская лопата







		axb	∅			
17400	1,70 mm	325x325 mm	42 mm	600 mm/ DM/DP/T	1,50 kg	10

SPANISH SHOVEL 

İSPANYOL KÜREĞİ / PELLE ESPAGNOLE
جاروف اسباني / лопата испанская



		axb	∅			
17700	1,70 mm	300 x 340 mm	38 mm	1200 mm/S 1300 mm/S 600 mm/ DM/DP	1,40 kg	5



5250 MINER'S SHOVEL



5250 MADENCİ KÜREĞİ / PELLE DE MINE 5250
5250 جاروف عامل المنجم / 5250 шахтерская лопата

		axb	\emptyset			
17500	1,70 mm	260 x 330 mm	38 mm	T/DM/DP	1,00 kg	20

5250 is a multi purpose shovel which is used in gardening and construction to dig or transfer different types of material.





5250 madenci küreği, bahçecilik ve inşaat işlerinde farklı malzemeleri aktarmak, kazmak veya bellemek için kullanılan çok amaçlı bir kürektir.

5250 MINER'S SHOVEL (DM HANDLE)



5250 MADENCİ KÜREĞİ (DM SAPLI) / PELLE DE MINE 5250 AVEC MANCHE DM
(DM بعضا) 5250 جاروف عامل المنجم / 5250 шахтерская лопата с черенком dm



		axb	\emptyset			
17550	1,70 mm	260 x 330 mm	38 mm	600 mm/DM	2,40 kg	5

9001 SAND SHOVEL



9001 KUM KÜREĞİ / PELLE À SABLE 9001
9001 جاروف الرمال / 9001 песчаная лопата





		axb	\emptyset			
14700	1,70 mm	210 x 365 mm	36 mm	600 mm/DP/T	1,20 kg	10

9002 SAND SHOVEL



9002 KUM KÜREĞİ / PELLE À SABLE 9002
9002 جاروف الرمال / 9002 песчаная лопата



		axb	\emptyset			
14800	1,70 mm	235 x 340 mm	34 mm	T/DM/DP	1,40 kg	10

AMERICAN SHOVEL 

AMERIKAN KÜREĞİ / PELLE AMERICAINE
جاروف امريكي / американская лопата





		axb	\emptyset			
11900	1,70 mm	220 x 285 mm	36 mm	600 mm/ DM/DP/T	1,10 kg	20

FRENCH SHOVEL No 25 (SQUARE) 

FRANSIZ KÜREĞİ NO.25 (KÖŞELİ) / PELLE FRANCAISE 25 (CARRÉE)
25 جاروف فرنسي رقم / французская лопата ном.25 (квадратная)



		axb	\emptyset			
12500	1,70 mm	265 x 290 mm	38 mm	1200 mm/S 1300 mm/S	1,20 kg	10

AMERICAN SHOVEL W/STRAIGHT HANDLE 

AMERIKAN KÜREĞİ (DÜZ SAPLI) / PELLE AMERICAINE AVEC MANCHE DROITE
(بعصا مستوية) جاروف امريكي / американская лопата с прямым черенком



		axb	\emptyset			
11910	1,70 mm	220 x 285 mm	36 mm	1200 mm/S	2,35 kg	5

FRENCH SHOVEL No 27 

FRANSIZ KÜREĞİ NO.27 / PELLE FRANCAISE 27
27 جاروف فرنسي رقم / французская лопата ном.27







		axb	\emptyset			
12300	1,70 mm	280 x 270 mm	38 mm	1200 mm/S 1300 mm/S	1,00 kg	10

FRENCH SHOVEL No 29 

FRANSIZ KÜREĞİ NO.29 / PELLE FRANCAISE 29
29 جاروف فرنسي رقم / французская лопата ном.29



		axb	\emptyset			
12400	1,70 mm	295 x 285 mm	38 mm	1200 mm/S 1300 mm/S	1,10 kg	10

9101 HOLSTEINER SHOVEL



9101 HOLSTEINER KÜREĞİ / PELLE HOLSTEINER 9101
 9101 جاروف هولستينر / 9101 лопата голштинера



		axb	\emptyset			
11600	1,70 mm	240 x 275 mm	38 mm	1500 mm/C 1300 mm/C	1,00 kg	25

9101 HOLSTEINER SHOVEL W/CURVED HANDLE



9101 HOLSTEINER KÜREĞİ (EĞİK SAPLI) / PELLE ALLEMANDE 9101 À MANCHE COURBÉE
 9101 جاروف هولستينر (بعصا مائلة)
 / 9101 голштинской лопату с изогнутым черенком







9105 HOLLANDER SHOVEL



9105 HOLLANDER KÜREĞİ / PELLE HOLLANDER 9105
 9105 جاروف هولندي / 9105 лопата голландская



		axb	\emptyset			
15300	1,70 mm	245 x 295 mm	38 mm	1500 mm/C 1300 mm/C	1,02 kg	25

		axb	\emptyset			
11630	1,70 mm	240 x 275 mm	38 mm	1500 mm/C 1300 mm/C	2,30 kg	5

9310 SAND SHOVEL



9310 KUM KÜREĞİ / PELLE À ORDURE 1150
 9310 جاروف الرمال / 9310 песчаная лопата





		axb	\emptyset			
11700	1,70 mm	255 x 275 mm	38 mm	1500 mm/C 1300 mm/C	1,00 kg	25

9320 SAND SHOVEL



9320 KUM KÜREĞİ / PELLE À SABLE 9320
 9320 جاروف الرمال / 9320 песчаная лопата







		axb	\emptyset			
11800	1,70 mm	275 x 300 mm	38 mm	1500 mm/C 1300 mm/C	1,10 kg	25

9103 GARDEN SHOVEL 

9103 BAĖE KÜREĖİ / PELLE DE JARDINAGE 9103
9103 جاروف البستان / 9103 садовая лопата



		axb	∅			
15100	1,70 mm	210 x 265 mm	34 mm	1500 mm/C 1300 mm/C	0,80 kg	25

9104 GARDEN SHOVEL 

9104 BAĖE KÜREĖİ / PELLE DE JARDINAGE 9104
9104 جاروف البستان / 9104 садовая лопата







		axb	∅			
15200	1,70 mm	220 x 285 mm	34 mm	1500 mm/C 1300 mm/C	0,86 kg	25

9102 GARDEN SPADE 

9102 BEL KÜREĖİ DÜZ / PELLE DE JARDINAGE 9102
9102 جاروف الحدائق المسطح / 9102 садовая лопата





		axb	∅			
15000	1,70 mm	185 x 285 mm	34 mm	850 mm/T	0,90 kg	25

9300 POINTED SPADE 

9300 BEL KÜREĖİ / BÊCHE (PEU POINTUE) 9300
9300 جاروف الحدائق / 9300 остроконечная лопата







		axb	∅			
15900	1,70 mm	210 x 280 mm	38 mm	1500 mm/S 1300 mm/S	1,00 kg	25

9003 SQUARE SPADE 

9003 BEL KÜREĖİ DÜZ / PELLE À SABLE 9003
9003 جاروف الحدائق المسطح / 9003 квадратная лопата



		axb	∅			
14900	2,00 mm	195 x 280 mm	34 mm	600 mm/DP/T	0,95 kg	25

It is especially produced for digging and spading. Flat edge makes this shovel ideal for cutting roots and soil.

Özellikle bellemek ve kazmak için üretilen bu kürek düz ucu sayesinde kök ve toprağı kesmek için ideal bir yapıya sahip.

SNOW PUSHER (ALUMINIUM) YAPAR

KAR KÜREĞİ (ALÜMİNYUM) / PELLE ALLEMANDE À NEIGE (ALUMINIUM)
(جاروف الثلج (الومنيوم) / лопаткоулавливатель снега (алюминиевая)



		axb				
88006	2,00 mm	465 x 325 mm	30 mm	1400 mm/S	1,30 kg	10



The shovel made up of 2.00 aluminum which has a wide, curved and ribbed form is ideal for pushing snow off driveways and walkways.

Geniş, kavisli kaburgalı formuyla kar küremek için ideal olan bu kar küreği 2.00 mm alüminyum malzemeden üretilmiştir.

SNOW SHOVEL (GALVANIZED) YAPAR

KAR KÜREĞİ (GALVANİZ) / PELLE À NEIGE (GALVANISÉ)
(جاروف الثلج المجلفن / лопата для снега (оцинкованная)



		axb				
28004	1,20 mm	465 x 325 mm	30 mm	1400 mm/S	1,90 kg	10

SNOW SHOVEL (GALVANIZED) w/ HANDLE YAPAR

KAR KÜREĞİ GALVANİZ (SAPLI) / PELLE À NEIGE (GALVANISÉ) AVEC MANCHE
(جاروف الثلج المجلفن (بعضا) / маленькая лопата для снега (алюминиевая) с черенком

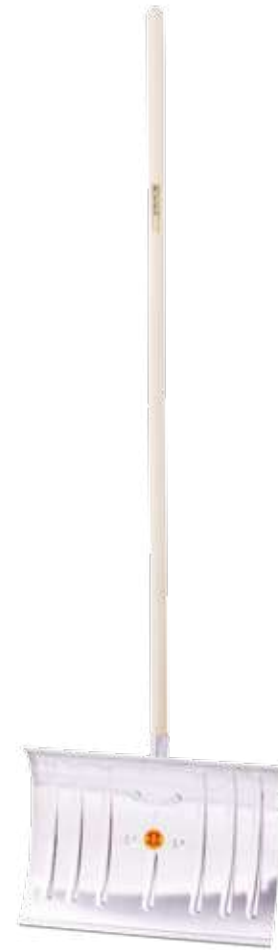





		axb				
28024	1,20 mm	460 x 325 mm	30 mm	1400 mm/S	2,70 kg	10

SMALL SNOW SHOVEL (ALUMINIUM) W/DP HANDLE YAPAR

KÜÇÜK KAR KÜREĞİ ALÜMİNYUM (DP SAPLI) / PETITE PELLE À NEIGE (ALUMIUM) - AVEC MANCHE DP
(DP بعضا) جاروف الثلج الومنيوم / маленькая лопата для снега (алюминиевая) с черенком DP



		axb				
83166	2,00 mm	265 x 300 mm	30 mm	DP	0,90 kg	5

PLASTIC SNOW SHOVEL NO 4



4 NO KAR KÜREĞİ (PLASTİK) / PELLE EN PLASTIQUE NUMÉRO 4
 جاروف الثلج رقم 4 (بلاستيك) / пластиковая лопата для снега ном. 4



↔	axb	∅			
97506	300 x 370 mm	38 mm	1300 mm/S	0,55 kg	25

PLASTIC SNOW SHOVEL NO 4 W/ HANDLE



4 NO KAR KÜREĞİ PLASTİK (SAPLI) / PELLE À NEIGE EN PLASTIQUE NUMÉRO 4 AVEC MANCHE
 جاروف الثلج رقم 4 بلاستيك (بعصا)
 пластиковая лопата для снега ном. 4 с черенком



↔	axb	∅			
97516	300 x 370 mm	38 mm	1300 mm/S	1,90kg	10

PLASTIC SNOW SHOVEL NO 4



4 NO KAR KÜREĞİ (PLASTİK) / PELLE À NEIGE EN PLASTIQUE NUMÉRO 4
 جاروف الثلج رقم 4 (بلاستيك) / пластиковая лопата для снега ном.4



↔	axb	∅			
97606	300 x 460 mm	38 mm	1300 mm/S 600 mm/S DM/DP/T	0,58kg	25

PLASTIC SNOW SHOVEL NO 5



5 NO KAR KÜREĞİ (PLASTİK) / PELLE EN PLASTIQUE NUMÉRO 5
 جاروف البناء رقم 5 / пластиковая лопата для снега ном. 5



↔	axb	∅			
97526	340 x 430 mm	38 mm	1300 mm/S	0,76kg	25

PLASTIC SNOW SHOVEL NO 5



5 NO KAR KÜREĞİ (PLASTİK) / PELLE À NEIGE EN PLASTIQUE NUMÉRO 5
 جاروف الثلج رقم 5 (بلاستيك) / пластиковая лопата для снега ном:5



↔	axb	∅			
97626	340 x 527 mm	38 mm	1300 mm/S 600 mm/S DM/DP/T	0,75kg	25

SQUARE MOUTH SHOVEL (PLASTIC) YAPAR

FARYAP KÜREĞİ (PLASTİK) / PELLE CARRÉE PLASTIQUE
 جاروف فاريب بلاستيك / лопата с квадратным ртом (пластиковая)



↔	axb	∅			
97166	290 x 370 mm	38 mm	1300 mm/S	0,54 kg	20

SQUARE MOUTH SHOVEL (PLASTIC) W/DP HANDLE YAPAR

FARYAP KÜREĞİ (PLASTİK) DP SAPLI / PELLE CARRÉE PLASTIQUE AVEC MANCHE DP
 جاروف فاريب بلاستيك (بعضا DP)
 лопата квадратного рта (пластиковая) с ручкой DP (дп)



↔	axb	∅			
97176	290 x 370 mm	38 mm	600 mm/DP	1,20 kg	5

SQUARE MOUTH SHOVEL (PLASTIC) FUZE

FARYAP KÜREĞİ (PLASTİK) / PELLE CARRÉE PLASTIQUE
 جاروف فاريب بلاستيك / лопата с квадратным ртом (пластиковая)





↔	axb	∅			
97206	290 x 370 mm	38 mm	600 mm/DP	0,47 kg	20

GRAIN SHOVEL (PLASTIC) YAPAR

ZAHİRE KÜREĞİ (PLASTİK) / PELLE À GRAIN PLASTIQUE
 جاروف الحبوب البلاستيك / зерновая лопата (пластиковая)



↔	axb	∅			
97246	370 x 460 mm	38 mm	1300 mm/S	0,80 kg	10

This plastic grain shovel is ideal for moving corrosive and granular materials (grain, salt, animal feed etc.). Aluminum collar and aluminum blade at the end increases the durability of the shovel.

Plastik zahire küreği korozif ve tanecikli malzemelerin (tahıl, tuz, yem vb.) taşınması için idealdir. Alüminyum boyunluk ve uç kısımdaki alüminyum çita küreğin dayanıklılığını arttıran önemli unsurlardır.

GRAIN SHOVEL (PLASTIC) FUZE

ZAHİRE KÜREĞİ (PLASTİK) / PELLE À GRAIN PLASTIQUE
جاروف الحبوب البلاستيك / зерновая лопата (пластиковая)



↔	axb	∅	🍷	📦	🌿
97286	370 x 460 mm	38 mm	600 mm/DP 1300 mm/S	0,73 kg	10

PUSHER (PLASTIC) FUZE

KÜREYİCİ (PLASTİK) / GRATTOIR EN PLATIQUE
مكشطة بلاستيكية / толкатель снега (пластиковый)



↔	axb	∅	🍷	📦	🌿
97126	410 x 230 mm	28 mm	1400 mm/S	0,48 kg	20

GRAIN SHOVEL (PLASTIC) W/DP HANDLE YAPAR

ZAHİRE KÜREĞİ (PLASTİK) DP SAPLI / PELLE A GRAIN PLASTIQUE AVEC MANCHE DP
(DP) جاروف الحبوب البلاستيك (بعضاً) / зерновая лопата (пластиковая) с ручкой DP (дп)



↔	axb	∅	🍷	📦	🌿
97256	370 x 460 mm	38 mm	600 mm/DP	1,42 kg	5

PUSHER (PLASTIC) YAPAR

KÜREYİCİ (PLASTİK) / GRATTOIR EN PLATIQUE
مكشطة بلاستيكية / толкатель снега (пластиковый)

↔	axb	∅	🍷	📦	🌿
97086	410x 230 mm	28 mm	1400 mm/S	0,50 kg	20

Plastic Pusher is used to clean snow and trash from flat surfaces. Ideal for public usage areas. Besides it is used in livestock to clean stables and corrals.

Plastik Küreyici düz yüzeylerden kar ve çöpleri temizlemek için kullanılır. Okul hastane bahçeleri, metro tramvay peronları için idealdir. Ayrıca ahır ve ağılları temizlemek için hayvancılıkta kullanılır.

SNOW PUSHER



PLASTİK KAR KÜREYİCİ / POUSSE NEIGE
مجرفة الثلج البلاستيك / толкатель снега



	axb	\emptyset			
97546	225 x 485 mm	28 mm	1400 mm/S	0,82 kg	10

PLASTIC SCRAPER W/ HANDLE



PLASTİK GELBERİ / RACLOIR EN PLASTIQUE
جالبيري بلاستيك / пластиковый скребок с черенком



PLASTIC SCRAPER



PLASTİK GELBERİ / RACLOIR EN PLASTIQUE
جالبيري بلاستيك / пластиковый скребок



	axb	\emptyset			
97006	410 x 230 mm	28 mm	1400 mm/S	0,52 kg	20



	axb	\emptyset			
97016	410 x 230 mm	28 mm	1400 mm/S	1,32 kg	5

PLASTIC SCRAPER



PLASTİK GELBERİ / RACLOIR EN PLASTIQUE
جالبيري بلاستيك / пластиковый скребок



	axb	\emptyset			
97046	410 x 230 mm	28 mm	1400 mm/S	0,50 kg	20

MILD STEEL SCRAPER



DEMİR GELBERİ / RACLOIR EN ACIER DOUX
جالبيري الحديد / скребок (м. сталь)



	axb	\emptyset			
99440	400 x 130 mm	32 mm	1400 mm/S	0,95 kg	10



HANDLES

Saplar
Poignées
المقابض
Черенки

Handles produced by processing trees such as beech, ash tree and hornbeam that are considered as solid wood trees in computerized machines, and drying the moisture content in electronic furnaces, provide ease of use with its ergonomic design.

Sert ahşap ağaç olarak nitelendirilen kayın, dişbudak ve gürgen gibi ağaçların bilgisayar kontrollü makinalarda işlenmesi ve elektronik kontrollü fırınlarda nem oranının kurutulmasıyla üretilen saplar, ergonomik yapısıyla büyük bir kullanım kolaylığı sağlamaktadır.

Poignées offrant une facilité d'utilisation grâce à leur forme ergonomique, sont produites à partir des arbres de bois massifs comme le hêtre, frêne et charme) et sont traitées dans des machines informatisées et des fours électroniques (séchage).

مقابض المنتجة بتجفيف معدل الرطوبة في الأفران المتحكم بها إلكترونيا ومعالجة الأشجار كالشرد و المُران و الزان التي توصف على أنها أشجار الخشب القاسي في مكائن متحكم بها بالحاسب، تؤمن سهولة استعمال كبيرة بتركيبتها المريحة .

Черенки, произведенные путем обработки деревьев, таких как бук, ясень и граб, которые считаются твердыми древесными деревьями в компьютеризированных машинах, и сушки влажности в электронных Печах, обеспечивают простоту использования с его эргономичным дизайном.



Code / Kod / Code / Код

الرمز



Dimensions/ Ölçüler / Dimensions / Размеры

القياسات



Diameter / Çap / Diamètre / Диаметр

الدائرة قطر



Handle Type / Sap Tipi / Type De Manche / Тип Черенок

نوع المقبض



Weight / Ağırlık / Poids / Вес

الوزن



Bundle Qty. / Bağ Adedi / Botte Quantité / Количество Пачки

عدد الربطة

CURVED SHOVEL HANDLES



EĞİK KÜREK SAPLARI / MANCHE COURBÉE DE PELLE

عصي الجاروف المائلة / изогнутый черенок для лопаты



41750	1500 mm	34-42 mm	Curved	1,25 kg	25
41730	1300 mm	34-40 mm	Curved	1,10 kg	25

STRAIGHT SHOVEL HANDLES



DÜZ KÜREK SAPLARI / MANCHE DROITE DE PELLE

عصي الجاروف المستوية / прямой черенок для лопаты



41650	1500 mm	34-42 mm	Straight	1,26 kg	25
41630	1300 mm	34-42 mm	Straight	1,05 kg	25
41620	1200 mm	34-40 mm	Straight	0,62 kg	25

SHOVEL HANDLE



DÜZ KÜREK SAPI / MANCHE DE PELLE

مقابض الجاروف / черенки для лопат



49650	1500 mm	34 - 42 mm	Straight	1,20 kg	25



HANDLES WITH GRIP



TUTAMAKLI SAPLAR / MANCHE DE PELLE ANGLAISE
عصي بيمسك / черенки с рукояткой

					
41120	600 mm	36-42 mm	DM	0,80 kg	25
41130	700 mm	36-42 mm	DM	0,85 kg	25
41210	600 mm	36-42 mm	DP	0,62 kg	25
41220	700 mm	36-42 mm	DP	0,68 kg	25
41340	850 mm	31-38 mm	T	0,60 kg	25

D and T shaped handles are produced from beech. The humidity of handles decreased to appropriated values in a kiln under observation and produced in different sizes and shapes.

D ve T şeklindeki saplar kayın ağacından üretilmektedir. Sapların nemleri gözlem altında fırınlanarak uygun değerlere indirilip farklı boy ve şekillerde üretim yapılmaktadır.

RAKE HANDLE



TIRMIK SAPI / MANCHE DE RÂTEAU
عصا المشط / черенок для граблей



					
41500	1400 mm	30 mm	Straight	0,75 kg	25

RAKE HANDLE



TIRMIK SAPI / MANCHE DE RATEAU
عصا المشط / черенок для граблей







					
49500	1400 mm	30 mm	Straight	0,85 kg	25

PICK AXE HANDLE



KAZMA SAPI / MANCHE DE PIOCHE
عصا المعول / черенок кирки



				
41100	900 mm	39,5-49 mm	Straight	0,95 kg

PICK AXE HANDLE



KAZMA SAPI / MANCHE DE PIOCHE
عصا المعول / черенок кирки



					
49100	900 mm	36,5 - 49 mm	Straight	0,75 kg	25

AXE HANDLES



BALTA SAPLARI / MANCHE DE HANCHE (DROITE)
عصا البلطة / черенок топора



41460	900 mm	39-56 mm	Straight	0,82 kg	25
41470	900 mm	39-56 mm	Orthopedic	0,70 kg	25

AXE HANDLE



BALTA SAPI / MANCHE DE HACHE
مقبض البلطة / черенок топора



49460	900 mm	39 - 56 mm	Straight	0,60 kg	25

BRUSH HANDLES



FIRÇA SAPLARI / MANCHE DE BALAI
عصي الفرشاه / рукоятка щетки



41530	1200 mm	26 mm	Straight	0,45 kg
41550	1500 mm	26 mm	Straight	0,50 kg
41570	1750 mm	26 mm	Straight	0,65 kg
41590	2000 mm	26 mm	Straight	0,80 kg

BRUSH HANDLES



FIRÇA SAPLARI / MANCHE DE BALAI
مقابض الفرشاه / рукоятка щетки

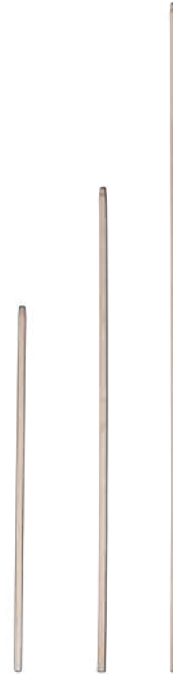





49530	1200 mm	24 mm	0,44 kg	25
49550	1500 mm	24 mm	0,50 kg	25
49590	2000 mm	24 mm	0,80 kg	25

ERGONOMIC HAMMER HANDLES



ORTOPEDİK ÇEKİC SAPI / MANCHE DE MARTEAU (ERGONOMIQUE)
عصي المطرقة الطبية / черенок молотка



	TIP				
41380	100 g	260 mm	Orthopedic	0,07 kg	50
41390	200 g	280 mm	Orthopedic	0,08 kg	50
41400	300 g	300mm	Orthopedic	0,12 kg	50
41410	500 g	320 mm	Orthopedic	0,13 kg	50
41420	800 g	350 mm	Orthopedic	0,15 kg	50
41430	1000 g	360 mm	Orthopedic	0,20 kg	50
41440	1500 g	380 mm	Orthopedic	0,22 kg	50
41450	2000 g	400 mm	Orthopedic	0,24 kg	50

ADZE HANDLE



KESER SAPI / MANCHE D'HACHETTE
عصا القشور / черенок для keser (бук)



					
41060	450 mm	27-33 mm	Straight	0,33 kg	50

FOOT PRESS FOR SPADE



DEPKİ (BEL KÜREĞİ AYAK BASKISI) / MANCHE BÉQUILLE
(مداس القدم لجاروف الحدائق) / دبيكي / пресса ноги для лопаты



				
41790	290 mm	40 mm	0,40 kg	25

FOOT PRESS FOR SPADE



DEPKİ (BEL KÜREĞİ AYAK BASKISI) / PRESSE-PIED DE BÊCHE
(مداس القدم لجاروف الحدائق) / دبيكي / пресса ноги для лопаты



				
49796	290 mm	40 mm	0,40 kg	25



GARDEN TOOLS

Bahçe Ekipmanları
Outils De Jardin
أدوات الحدائق
Садовые Инструменты

Muhtelif kullanım amaçlarına yönelik özel olarak tasarlanan YAPARLAR tırmık ve çapa modelleri, Endüstriyel Boya veya Elektrostatik Fırınlı Toz Boya ile boyanmaktadır.

Specially designed for various intended uses, YAPARLAR rake and hoe models are painted with Industrial Paint or Electrostatic Furnace Powder Paint.

Spécialement conçu pour des diverses utilisations, les râteliers et les serfouettes YAPARLAR sont peints avec de la peinture industrielle ou d'une peinture en poudre électrostatique.

نماذج يابارلار للمعزقة و مستط البستاني المصممة خصيصا لأهداف الاستعمال المختلفة يتم طلاؤها بطلاء صناعي أو مسحوق الطلاء بالفرن الالكتروستاتيكي .

Специально разработанные для различных целей, модели грабель и мотыг YAPARLAR окрашиваются промышленной краской или порошковой краской электростатической печи.





Code / Kod / Code / Код
الرمز



Thickness / Kalınlık / Epaisseur / Толщина
السماكة

a x b

Dimensions / Ölçüler / Dimensions / Размеры
القياسات

∅

Diameter / Çap / Diamètre / Диаметр
الدائرة قطر



Handle Type / Sap Tipi / Type De Manche / Тип Черенок
نوع المقبض



Weight / Ağırlık / Poids / Вес
الوزن



Bundle Qty. / Bağ Adedi / Botte Quantité / Количество Пачки
عدد الربطة

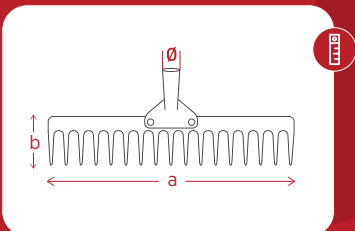

RAKE 10 TEETH 

TIRMIK 10 DİŞ / RÂTEAUX YAPAR 10 DENTS
اسنان 10 مشط / грабли 10 зубов



↔	→ ←	a x b	∅			
94100	5,00 mm	260 x 85 mm	28 mm	1400 mm	0,60 kg	12

RAKE 12 TEETH 

TIRMIK 12 DİŞ / RÂTEAUX YAPAR 12 DENTS
اسنان 12 مشط / грабли 12 зубов



↔	→ ←	a x b	∅			
94200	5,00 mm	315 x 85 mm	28 mm	1400 mm	0,70 kg	12

RAKE 14 TEETH 

TIRMIK 14 DİŞ / RÂTEAUX YAPAR 14 DENTS
اسنان 14 مشط / грабли 14 зубов



↔	→ ←	a x b	∅			
94300	5,00 mm	370 x 85 mm	28 mm	1400 mm	0,80 kg	12

RAKE 16 TEETH 

TIRMIK 16 DİŞ / RÂTEAUX YAPAR 16 DENTS
مشط 16 سن / грабли 16 зубов



		axb				
94400	5,00 mm	425 x 85 mm	28 mm	1400 mm	0,85 kg	12

RAKE 10 TEETH 

TIRMIK 10 DİŞ / RÂTEAUX 10 DENTS
مشط 10 اسنان / грабли 10 зубов



		axb				
95100	4,00 mm	265 x 85 mm	28 mm	1400 mm	0,50 kg	12

RAKE 18 TEETH 

TIRMIK 18 DİŞ / RÂTEAUX YAPAR 18 DENTS
مشط 18 سن / грабли 18 зубов









		axb				
94500	5,00 mm	480 x 85 mm	28 mm	1400 mm	0,95 kg	12

RAKE 12 TEETH 

TIRMIK 12 DİŞ / RÂTEAUX 12 DENTS
مشط 12 سن / грабли 12 зубов



		axb				
95200	4,00 mm	330 x 85 mm	28 mm	1400 mm	0,60 kg	12

RAKE 20 TEETH 

TIRMIK 20 DİŞ / RÂTEAUX YAPAR 20 DENTS
مشط 20 سن / грабли 20 зубов







		axb				
94600	5,00 mm	a: 535 x 85 mm	28 mm	1400 mm	1,00 kg	12

RAKE 14 TEETH 

TIRMIK 14 DİŞ / RÂTEAUX 14 DENTS
مشط 14 سن / грабли 14 зубов



		axb				
95300	4,00 mm	390 x 85 mm	28 mm	1400 mm	0,65 kg	12

RAKE 16 TEETH FUZE

TIRMIK 16 DİŞ / RÂTEAUX 16 DENTS
مشط 16 سن / грабли 16 зубов



↔	→ ←	axb	∅	☉	☐	≡
95400	4,00 mm	450 x 85 mm	28 mm	1400 mm	0,70 kg	12

METAL LEAF RAKE ADJUSTABLE



METAL YAPRAK TIRMIĞI (AYARLI) / RATEAU A FEUILLES REGLABLE
مشط ورق قابل للتعديل / грабли металлические листовые регулируемые



↔	→ ←	∅	☉	☐	≡
95009	1 mm	25 mm	-	0,45 kg	25

RAKE 18 TEETH FUZE

TIRMIK 18 DİŞ / RÂTEAUX 18 DENTS
مشط 18 سن / грабли 18 зубов



↔	→ ←	axb	∅	☉	☐	≡
95500	4,00 mm	505 x 85 mm	28 mm	1400 mm	0,80 kg	12

ONE PRONG FLOWER HOE



ÇİÇEK ÇAPASI SIVRİ / SERFOUETTE PANNE LANGUE
فأس الورد المدبب / тяпка с одинарным узким резцом



↔	→ ←	axb	∅	☉	☐	≡
99051	3,00 mm	70 x 265 mm	30 mm	-	0,35 kg	20

RAKE 20 TEETH FUZE

TIRMIK 20 DİŞ / RÂTEAUX 20 DENTS
مشط 20 سن / грабли 20 зубов



↔	→ ←	axb	∅	☉	☐	≡
95600	4,00 mm	565 x 85 mm	28 mm	1400 mm	0,90 kg	12

ONE PRONG FLOWER HOE W/HANDLE



ÇİÇEK ÇAPASI SIVRİ (SAPLI) / SERFOUETTE PANNE LANGUE (AVEC MANCHE)
فأس الورد المدبب (بعصا) / тяпка с одинарным узким резцом с черенком



↔	→ ←	axb	∅	☉	☐	≡
99031	3,00 mm	70 x 265 mm	30 mm	450 mm	0,555 kg	10

TWO PRONG FLOWER HOE 

ÇİÇEK ÇAPASI ÇATAL / SERFOUETTE PANNE FOURCHE
 فأس الورد ذو الشوكة / тяпка с двойными узкими резцами



		axb	\emptyset			
99061	3,00 mm	70 x 225 mm	30 mm	-	0,31 kg	20

TWO PRONG FLOWER HOE W/ HANDLE 

ÇATAL ÇİÇEK ÇAPASI (SAPLI) / SERFOUETTE PANNE FOURCHE (AVEC MANCHE)
 فأس الورد المدبب ذو الشوكة (بعضاً) / тяпка с двойными узкими резцами с черенком

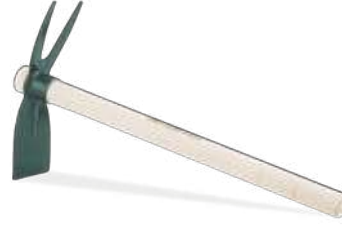





		axb	\emptyset			
99041	3,00 mm	70 x 225 mm	30 mm	450 mm	0,515 kg	10

ONE PRONG FLOWER HOE 

ÇİÇEK ÇAPASI SIVRİ / SERFOUETTE PANNE LANGUE
 فأس الورد المدبب / тяпка с одинарным узким резцом



		axb	\emptyset			
99651	3 mm	70 x 240 mm	30 mm	-	0,27 kg	20

ONE PRONG FLOWER HOE W/ HANDLE 

ÇİÇEK ÇAPASI SIVRİ (SAPLI) / SERFOUETTE PANNE FOURCHE (AVEC MANCHE)
 فأس الورد المدبب (بعضاً) / тяпка с одинарным узким резцом с черенком



		axb	\emptyset			
99631	3 mm	70 x 240 mm	30 mm	450 mm	0,47 kg	10

TWO PRONG FLOWER HOE 

ÇİÇEK ÇAPASI ÇATAL / SERFOUETTE PANNE FOURCHE
 فأس الورد ذو الشوكة / тяпка с двойными узкими резцами



		axb	\emptyset			
99661	3 mm	70 x 230 mm	30 mm	-	0,51 kg	20

TWO PRONG FLOWER HOE W/ HANDLE 

ÇATAL ÇİÇEK ÇAPASI (SAPLI) / SERFOUETTE PANNE FOURCHE (AVEC MANCHE)
 فأس الورد المدبب ذو الشوكة (بعضاً) / тяпка с двойными узкими резцами с черенком



		axb	\emptyset			
99641	3 mm	70 x 230 mm	30 mm	450 mm	0,44 kg	10

PLANE GARDEN HOE



BAHÇE ÇAPASI DÜZ / HOUE DE JARDINAGE
فأس البستان المسطح / садовая мотыгапрямая



↔	→←	axb	∅	☹	📦	⌘
93461	4,00 mm	65 x 236 mm	30 mm	-	0,37 kg	25

PLANE GARDEN HOE W/ HANDLE



BAHÇE ÇAPASI DÜZ (SAPLI) / HOUE DE JARDINAGE À PANNE LONGUE AVEC MANCHE
فأس البستان المسطح (بعصا) / садовая мотыга с черенком



↔	→←	axb	∅	☹	📦	⌘
93471	4,00 mm	65 x 236 mm	30 mm	700 mm/S	0,70 kg	10

TWO PRONG GARDEN HOE



BAHÇE ÇAPASI ÇATAL / HOUE DE JARDINAGE À DEUX BROCHES
فأس البستان ذو الشوكة / садовая мотыга с двойными узкими резцами



↔	→←	axb	∅	☹	📦	⌘
93441	4,00 mm	65 x 230 mm	34,5 mm	-	0,35 kg	25

TWO PRONG GARDEN HOE W/ HANDLE



BAHÇE ÇAPASI ÇATAL (SAPLI) / HOUE DE JARDINAGE À PANNE FOURCHE AVEC MANCHE
فأس البستان ذو الشوكة (بعصا) / садовая мотыга с двойными узкими резцами с черенком

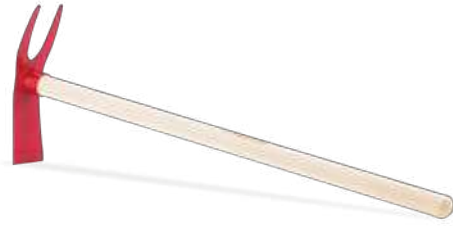

↔	→←	axb	∅	☹	📦	⌘
93451	4,00 mm	65 x 230 mm	34,5 mm	700 mm/S	0,66 kg	10

BIG GARDEN HOE



BÜYÜK BAHÇE ÇAPASI / GRANDE HOUE DE JARDINAGE
فأس البستان الكبير / большая садовая мотыга



↔	→←	axb	∅	☹	📦	⌘
93401	4,00 mm	150 x 225 mm	44 mm	-	0,85 kg	15

BIG GARDEN HOE W/ HANDLE



BÜYÜK BAHÇE ÇAPASI (SAPLI) / GRANDE HOUE DE JARDINAGE AVEC MANCHE
فأس البستان الكبير (بعصا) / большая садовая мотыга с черенком



↔	→←	axb	∅	☹	📦	⌘
93411	4,00 mm	150 x 225 mm	44 mm	1200 mm/S	1,90 kg	10

SMALL GARDEN HOE



KÜÇÜK BAHÇE ÇAPASI / PETITE HOUE DE JARDINAGE
فأس البستان الصغير / маленькая садовая мотыга



↔	→ ←	axb	∅			
93421	4,00 mm	107 x 170 mm	34,5 mm	-	0,45 kg	25

SMALL GARDEN HOE w/ HANDLE



KÜÇÜK BAHÇE ÇAPASI (SAPLI) / PETITE HOUE DE JARDINAGE AVEC MANCHE
فأس البستان الصغير (بعصا) / маленькая садовая мотыга с черенком



↔	→ ←	axb	∅			
93431	4,00 mm	107 x 170 mm	34,5 mm	900 mm/S	0,95 kg	10

ONE-PIECE MOON HOE



YEKPARE AY ÇAPA / BINETTE DE LUNE
معزقة قمر / половина луны мотыгой



↔	→ ←	axb	∅			
93610	3 mm	270 x 135 mm	34 mm	-	0,95 kg	6
93612	3 mm	270 x 135 mm	34 mm	900 mm/S	1,35 kg	6

ONE-PIECE MOON HOE FLAT



YEKPARE AY ÇAPA DÜZ / BINETTE DE LUNE (PLATE)
معزقة قمر عريض / половина луны мотыгой (широкая)



↔	→ ←	axb	∅			
93620	3 mm	270 x 100 mm	34 mm	-	0,79 kg	6
93622	3 mm	270 x 100 mm	34 mm	900 mm/S	1,15 kg	6

ONE-PIECE MOON HOE SHARP



YEKPARE AY ÇAPA SIVRİ / BINETTE DE LUNE (POINTUE)
معزقة قمر حاد / половина луны мотыгой (заостренная)



↔	→ ←	axb	∅			
93630	3 mm	190 x 160 mm	34 mm	-	0,85 kg	6
93632	3 mm	190 x 160 mm	34 mm	900 mm/S	1,25 kg	6

BAKING METAL SHEET



EKMEK SACI / BASSIN MÉTALLIQUE
صاج الخبز / выпечка металлического листа



↔	→ ←	TYPE	∅		
91636	1,50 mm	Plane	∅ 40-45-50-55-60-65-70-75-80-85-90	-50 kg	
91536	1,50 mm	Deep	∅ 35-40-45-50-55-60-65-70-75	-50 kg	



CONSTRUCTION EQUIPMENTS

İnşaat Ekipmanları
Équipements de Construction

معدات الطيان و النجار
Строительные Оборудования

Molding and plastering equipment produced for general and specific uses provide comfortable installation and use for professionals.

Genel ve spesifik kullanım için özel olarak üretilen kalıp ve sıvacı ekipmanları, işin uzmanları için rahat bir kurulum ve kullanım imkânı sunmaktadır.

Les moules et les équipements de plâtrerie produits pour l'utilisation générale et spécifique offrent une installation et utilisation facile pour les professionnels.

معدات الطيان و النجار المنتجة خصيصا للاستعمال العام و المحدد تقدم إمكانية الاستعمال و التركيب المريح من أجل المختصين في العمل .

Формовочные и штукатурные оборудования, производимое для общего и специального применения, обеспечивает удобная установка и использование для профессионалов.





Code / Kod / Code / Код

الرمز



Thickness / Kalınlık / Epaisseur / Толщина

السماكة



Dimensions / Ölçüler / Dimensions / Размеры

القياسات



Handle Type / Sap Tipi / Type De Manche / Тип Черенок

نوع المقبض



Weight / Ağırlık / Poids / Вес

الوزن



Bundle Qty. / Bağ Adedi / Botte Quantité / Количество Пачки

عدد الربطة



Diameter / Çap / Diamètre / Диаметр

الدائرة قطر

STEEL MORTAR PAN



METAL HARÇ TEKNESİ / BAC POUR MORTIER

الحوض المعدني لخلطة الاسمنت / стальной лоток ступки с сжатием руки

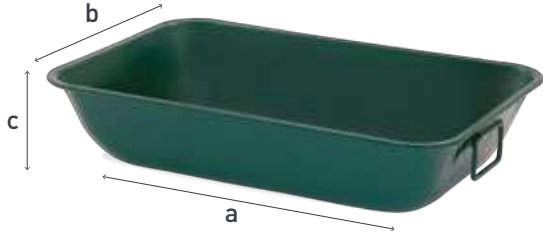

↔	→←	📏	👤	📦	📦
96241	0,80 mm	a: 685 mm b: 450 mm c: 150 mm	w/Grip	3,35 kg	1
96251	0,80 mm	a: 685 mm b: 450 mm c: 150 mm	w/o Grip	3,20 kg	1

STEEL MORTAR PAN (GALVANIZED)



GALYANİZLİ HARÇ TEKNESİ / BAC POUR MORTIER GALVANISÉ

الحوض المعدني لخلطة الاسمنت (نفاذم) / стальной лоток (Оцинкованный)



↔	→←	📏	👤	📦	📦
96244	0,80 mm	a: 685 mm b: 450 mm c: 150 mm	w/Grip	3,25 kg	1
96254	0,80 mm	a: 685 mm b: 450 mm c: 150 mm	w/o Grip	3,10 kg	1

TENSOR CLAMP



ÇİROZ SIKMA ALETİ / APPLICATEUR POUR CLIPS

الة شد تشيروز ذو ذراع / тензорный зажим с ручкой



↔	👤	📦	📦
92424	w/Handle	3,15 kg	2
92444	w/Lever	3,55 kg	2

CLAMP FOR CONCRETE CASTING MOULD



KALIP KİLİDİ (ÇİROZ) / CLIPS DE BÉTON

(قفل القالب (تشيروز / зажим для бетонной литейной формы



				
92450	 4mm  4mm  6mm	a: 75mm b: 110mm ϕ : 8mm	0,40 kg	50

TIE-ROD



TIE-ROD (TAYROT) MILİ / TIGE DE COFFRAGE

TIE-ROD قضييب شد / тяга

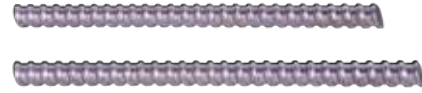

		ϕ		
92500	1,00 m	17 mm	1,44 kg	10
92510	1,20 m	17 mm	1,70 kg	10
92520	1,50 m	17 mm	2,13 kg	10
92530	2,00 m	17 mm	2,84 kg	10
92540	3,00 m	17 mm	4,30 kg	10

CLAMP FOR CONCRETE CASTING MOULD



KALIP KİLİDİ (ÇİROZ) / CLIPS DE BÉTON

(قفل القالب (تشيروز / зажим для бетонной литейной формы



				
92460	 4mm  2,5mm  6mm	a: 75mm b: 105mm ϕ : 8mm	0,38 kg	50

TIE-ROD NUT ϕ 70 mm



TIE-ROD (TAYROT) SOMUN ϕ 70 mm / ECROUS DE COFFRAGE

TIE-ROD قضييب شد / тяга гайка



	ϕ		
92550	17 mm	0,26 kg	50

CLAMP FOR CONCRETE CASTING MOULD



KALIP KİLİDİ / CLIPS DE BÉTON

(قفل القالب (تشيروز / зажим для бетонной литейной формы



				
92440	 3mm  2,5mm  5mm	a: 75mm b: 100mm ϕ : 8mm	0,30 kg	50





TIE-ROD WASHER



TIE-ROD (TAYROT) AYNASI / ENTRETOISE DE COFFRAGE

TIE-ROD مر بظ قضييب شد / шайба для рулевой тяги



		a x b	ϕ		
92580	3,00 mm	a: 110 mm x b: 110 mm	17 mm	0,18 kg	50

WRECKING BARS



SÖKÜ DEMİRLERİ / BARRES DE DÉMOLITION
العنلات الحديدية / вредительство бары



↔	↔	📏	📦	📊
92300	19 mm	500 mm	1,50 kg	5
92310	19 mm	550 mm	1,55 kg	5
92320	19 mm	600 mm	1,70 kg	5
92330	19 mm	900 mm	2,60 kg	5
92340	19 mm	1000 mm	2,85 kg	5
92350	19 mm	1100 mm	3,10 kg	5
92360	19 mm	1200 mm	3,35 kg	5
92370	19 mm	1300 mm	3,60 kg	5
92380	19 mm	1400 mm	3,90 kg	5
92390	19 mm	1500 mm	4,20 kg	5

BLUE PICK AXE



MAVİ KAZMA / PIOCHE
معول أزرق / синяя кирка

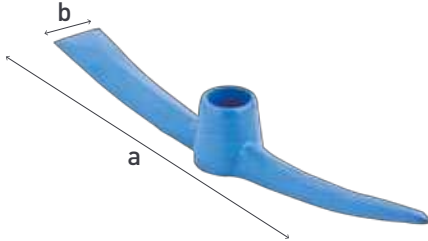

↔	axb	📏	∅	📦	📊
93100	a: 490 mm b: 52 mm	-	40 - 45 mm	2,00 kg	6
93120	a: 490 mm b: 52 mm	w/Handle	40 - 45 mm	2,95 kg	5

GREEN PICK AXE



YEŞİL KAZMA / PIOCHE
معول اخضر / зеленая кирка



KOD	axb	📏	∅	📦	📊
93140	a: 490 mm b: 53 mm	-	40 - 45 mm	2,20 kg	6
93150	a: 490 mm b: 53 mm	w/Handle	40 - 45 mm	3,15 kg	5

PLUS ADZE w/ HANDLE



KESER PLUS SAPLI / MARTEAU DE CHARPENTIER AVEC MANCHE PLUS
قدم بعضا اكسترا / плюс кесер с ручкой



↔	axb	📏	📦	📊
99081	a: 114 mm b: 41 mm	450 mm	0,65 kg	6

CHISEL - POINTED CHISEL



MURÇ - KESKİ / BURIN PLAT - BURIN POINTU
ازمیل - اسفین / зубило - остроконечное зубило



↔	TYPE	📏	📏	📦	📊
92400	Pointed	300 mm	-	0,67 kg	12
92470	Pointed	300 mm	w/ Grip	0,73 kg	12
92410	-	300 mm	-	0,65 kg	12
92480	-	300 mm	w/ Grip	0,77 kg	12

BLACK PICK AXE



SİYAH KAZMA / PIOCHE
معول اسود / черная кирка



↔	axb	📏	∅	📦	📊
93300	a: 460 mm b: 50 mm	-	40 - 45 mm	1,80 kg	6
93130	a: 460 mm b: 50 mm	w/Handle	40 - 45 mm	2,75 kg	5

MATTOCK



BALTALI KAZMA / PIOCHE HACHE
معول مع بلطة / мотыга



↔	axb	📏	∅	📦	📊
93180	a: 420 mm b: 60 mm	-	40 - 45 mm	1,60 kg	6
93190	a: 420 mm b: 60 mm	w/Handle	40 - 45 mm	2,55 kg	5

© Copyright 2020

"Yaparlar reserves the right to change the products specification at anytime."

"Our company is not responsible for typographical and printing errors in this catalog."

"The copyrights of the product images used in this cataloge are owned by YAPARLAR and can not be copied or reproduced without our permission."

"Yaparlar ürün özelliklerinde önceden haber vermeksizin değişiklik yapma hakkına sahiptir."

"Firmamız bu katalogdaki yazım ve basım hatalarından sorumlu değildir."

"Kullanılan ürün görsellerinin telif hakları firmamıza aittir. İzinsiz kopyalanamaz ve çoğaltılamaz."





YAPARLAR İNŞAAT VE TARIM ALETLERİ SANAYİ VE TİCARET A.Ş.

Genel Merkez & İstanbul Fabrika:
Cebeci Cad. No. 115 Küçükköy, 34250 İstanbul / TÜRKİYE
T. +90 212 477 27 37 F. +90 212 538 00 25
info@yaparlar.com / export@yaparlar.com / satis@yaparlar.com

Malatya Fabrika:
2. Organize Bölgesi 2. Cad. No:8 Yeşilyurt - Malatya / TÜRKİYE

yaparlar.com

