

# PRODUCT BROCHURE



# INDEX

## 04-05 **MANUAL PALLET TRUCKS**

06-07 **YAPAR PRO YPT25**

08-09 **YAPAR FLEX FPT25**

10-11 **YAPAR PRO YPT30 - YAPAR PRO YPT25 (WIDE)**

12-13 **YAPAR PRO YPT25 (800 mm) - YAPAR PRO YPT25 (1500 mm)**

14-15 **YAPAR PRO YPT20 (2000 mm) - YAPAR PRO YPT25 (CONSTRUCTION TYPE)**

16-17 **YAPAR PRO YPT25G - YAPAR PRO YPT25P**

18-19 **YAPAR PRO YPT20S - YAPAR PRO YPT20PS**

## 20-21 **ELECTRIC PALLET TRUCKS**

22-23 **YAPAR EP15-E - YAPAR EP20-E**

## 24-25 **HAND TRUCKS - PLATFORM TRUCKS**

26 **HT500 HAND TRUCKS**

27 **HT510 FOLDING HAND TRUCKS**

28 **HT200 - HT205 HAND TRUCKS**

29 **HT210 - HT215 FOLDING HAND TRUCKS**

30 **HT100 - HT105 HAND TRUCKS**

31 **HT140 - HT120 HAND TRUCKS**

32 **PP250S - PP250P PLATFORM TRUCKS**

33 **PP150S - PP150P PLATFORM TRUCKS**

## 34-35 **SPARE WHEELS & PALLET TRUCK SPARES**

34 **SPARE WHEELS**

35 **PALLET TRUCKS SPARES**

## YAPAR MATERIAL HANDLING

Founded in 1947, **YAPARLAR** is the industry leader in the construction and agriculture hand tools sector. For 79 years, **YAPARLAR** has been committed to produce the highest quality tools and operate at the highest international standards.

**YAPARLAR** is expanding its product range in the material handling equipment sector. The company applies the same core values and high industry standards in this new sector through offering of various hand trolleys and hand pallet trucks. **YAPAR Pallet Trucks** is one of the best well-designed equipment in this range.



**PALLET TRUCKS  
ARE THE NEWEST  
PRODUCT RANGE  
OF YAPARLAR,  
SHAPED BY 79  
YEARS OF  
MANUFACTURING  
EXPERTISE.**



[yaparmaterialhandling.com](http://yaparmaterialhandling.com)

[yaparlarm.com](http://yaparlarm.com)

## **MANUAL PALLET TRUCKS**

**YAPAR PRO YPT25 Manual Hand Pallet Truck** is developed based on **YAPARLAR's 79 years** of manufacturing experience. The product is manufactured with a fully automated robot-welded chassis to ensure dimensional accuracy, consistent production quality, and extended service life.

Reinforced stiffeners located under the forks are standard, providing increased structural strength and load stability. The **YPT25** combines optimized structural design with reliable manufacturing quality for long-term industrial use.

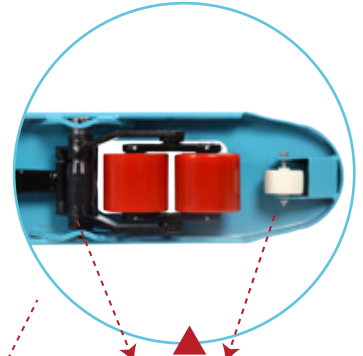
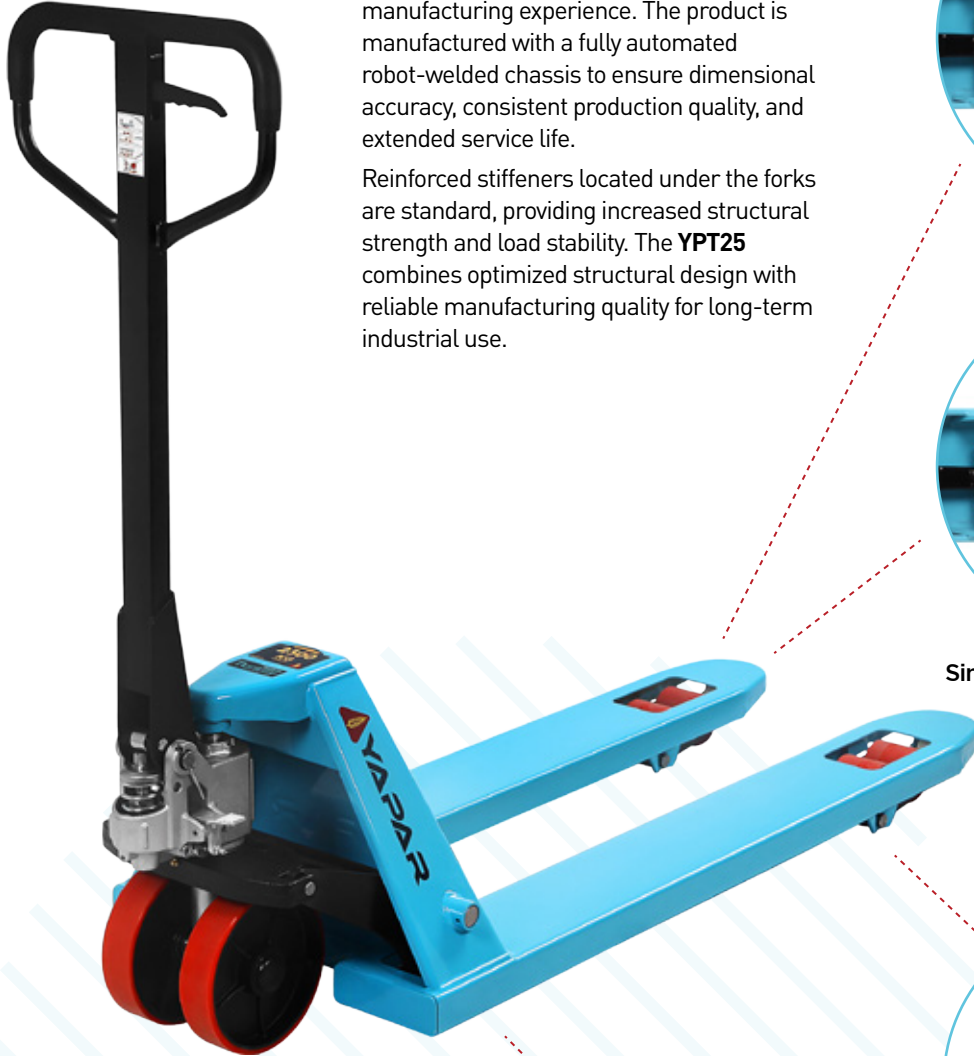

Entry/exit rollers

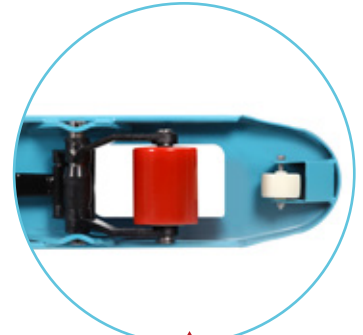

Single / Tandem load wheels



Reinforcing stiffeners under forks



Leak-proof and reliable BF type hydraulic pump



Fully automated robot welding chassis



# MANUAL PALLET TRUCK

**2500 KG**

MODEL	FORK LENGTH (mm)	OVERALL WIDTH (mm)	OVERALL LENGTH (mm)	SERVICE WEIGHT (kg)*
YPT25	1150	540	1550	62 - 67,2

**Capacity** : 2500 kg  
**Height Lowered** : 85 mm  
**Lift Height** : 115 mm  
**Ground Clearance** : 35 mm

**Tyre Types** : PU - Nylon - Rubber  
**Steering Wheels** : Ø200 x 50 - Ø180 x 50  
**Load Wheels** : Ø80 x 70 - Ø80 x 90  
**Wheel No (Steer/Load)** : 2/4 - 2/2

\* Service Weight depends on the wheel type requested

**The ergonomic handle provides a comfortable drive and the anti-slippery coverage offers safety during usage.**

**Every pallet truck comes with standard entry and exit guide rollers which help for effortless pallet entry and provide stability.**

Alternatives in the load and steering wheels create options to choose the most suitable pallet truck according to the user needs.

Equipped with high quality integrated hydraulic pump, **YAPAR PRO YPT25** offers long life time with low maintenance.



## Alternative Steering And Load Wheels



PU - Nylon Steering Wheels  
 • Ø200x50  
 • Ø180x50

RUBBER Steering Wheels  
 • Ø200x50



PU - Nylon Load Wheels  
 • Ø80 x 90  
 • Ø80 x 70



Long lasting high quality wheels



Ergonomic and comfortable handle with anti-slippery coverage



Strong chassis design

**YAPAR Flex** pallet truck features a fully automated robot-welded chassis and press rib reinforced forks, ensuring strength.

Equipped with a DF-type cast hydraulic pump, it offers a 2,500 kg load capacity for reliable performance.

Polyurethane and nylon wheel alternatives provide smooth and efficient operation, while its lightweight design and 100% quality control production process makes ease of use and safety.



DF type casting hydraulic pump



Fully automated robot welding chassis



Press rib forks



# MANUAL PALLET TRUCK | YAPAR FLEX

 2500 KG

**Capacity** : 2500 kg  
**Height Lowered** : 85 mm  
**Lift Height** : 200 mm  
**Ground Clearance** : 35 mm

**Wheel Types** : PU - Nylon  
**Steering Wheels** : Ø180 x 50  
**Load Wheels** : Ø70 x 60  
**Wheel No (Steer/Load)** : 2/4



## Alternative Steering and Load Wheels

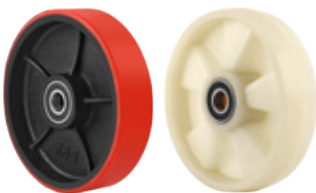

Polyurethane or Nylon  
Steering Wheels  
• Ø180 x 50



Polyurethane or Nylon  
Load Wheels  
• Ø 70 x 60



**Tandem Load Wheels**

**YAPAR PRO YPT30** pallet truck offers a solid design with a fully automatic robot welding chassis, lead to consistent production and longer usage time. With the extra reinforcing stiffeners under forks, **YAPAR PRO YPT30** is the combination of well designed structure and quality.



**3000  
KG**



Leak-proof and reliable hydraulic pump



Extra Reinforcing stiffeners unders forks and on axles



Standard entry/exit rollers

MODEL	FORK LENGTH (mm)	OVERALL WIDTH (mm)	OVERALL LENGTH (mm)	SERVICE WEIGHT (kg)*
YPT30	1150	540	1550	65 - 74

**Capacity** : 3000 kg  
**Height Lowered** : 85 mm  
**Lift Height** : 115 mm  
**Ground Clearance** : 35 mm

**Tyre Types** : PU - Nylon - Rubber  
**Steering Wheels** : Ø200 x 50 - Ø180 x 50  
**Load Wheels** : Ø80 x 70 - Ø80 x 90  
**Wheel No (Steer/Load)** : 2/4 - 2/2

\* Service Weight depends on the wheel type requested



**MANUAL PALLET TRUCK I WIDE**

**2500 KG / 5500 LB**

The **YAPAR PRO YPT25 Wide Pallet Truck** is designed for American-type pallets, featuring a robot-welded durable chassis and a high-quality hydraulic pump. Its reinforced forks ensure long service life, while the ergonomic, non-slip handle and entry-exit rollers provide safe, smooth, and efficient operation with low maintenance costs.

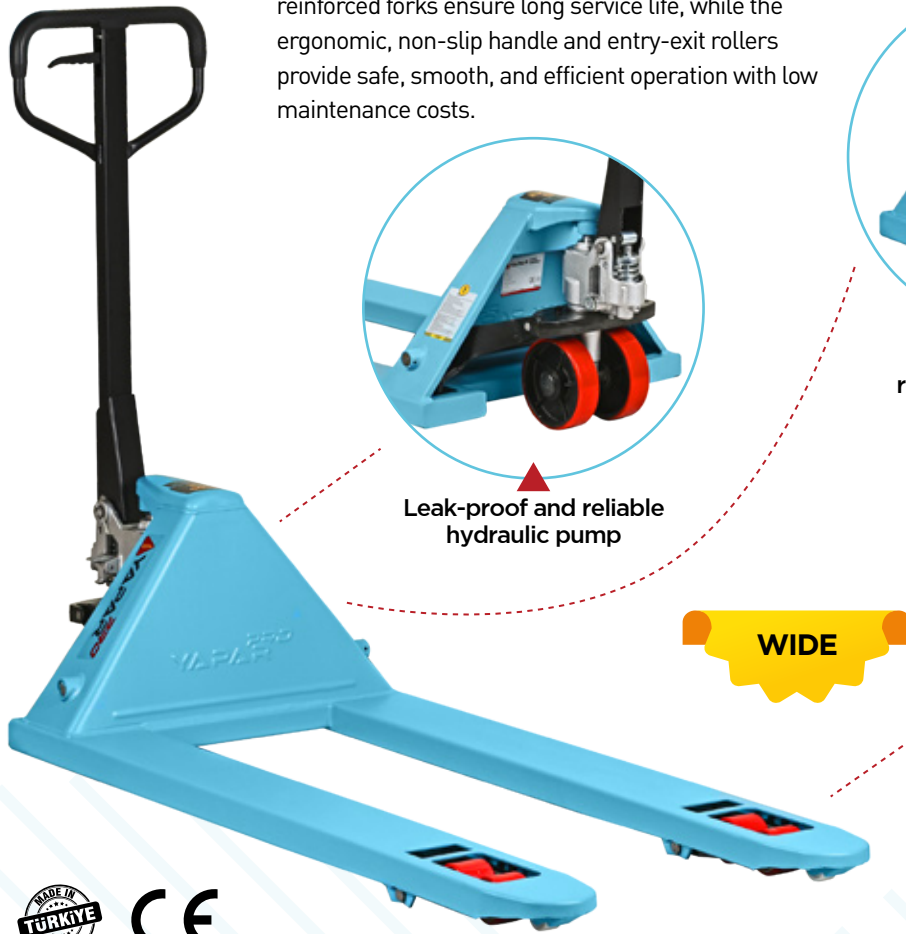

Leak-proof and reliable hydraulic pump

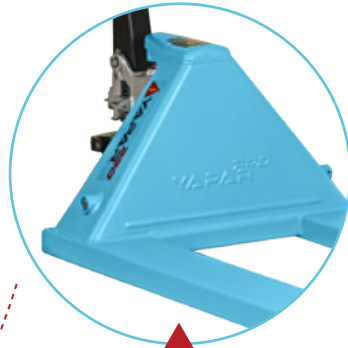

Fully automated robot welding chassis

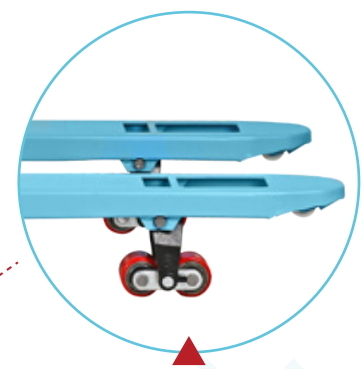

Tandem load wheels



MODEL	FORK LENGTH (mm/in)	OVERALL WIDTH (mm/in)	OVERALL LENGTH (mm/in)	SERVICE WEIGHT (kg/lbs)*
YPT25	1220/48	685/27	1620/638	71/32.27

**Capacity** : 2500 kg  
**Height Lowered** : 75 mm (3")  
**Lift Height** : 115 mm (4.53")  
**Ground Clearance** : 35 mm (1.38")

**Tyre Types** : PU - Nylon  
**Steering Wheels** : Ø180 x 50  
**Load Wheels** : Ø70 x 60  
**Wheel No (Steer/Load)** : 2/4

\* PU Tandem wheel weight

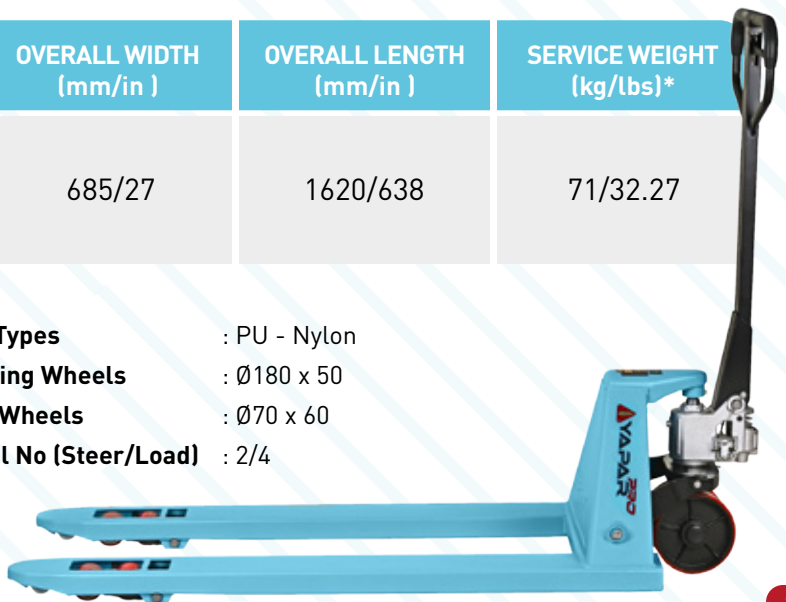

Featuring a robust, fully automatic robot-welded chassis, the YAPAR PRO YPT25 Short Hand Pallet Truck offers an extended service life through a precision manufacturing process.

Standard reinforcements under the forks, combined with a high-quality integrated hydraulic pump, ensure a well-designed and durable structure.

The ergonomic handle provides comfortable operation, while the non-slip coating enhances safety during use. Entry and exit roller wheels, supplied as standard, enable effortless pallet entry and improved stability.

The YAPAR PRO YPT25 Short Hand Pallet Truck delivers long-lasting performance with low maintenance requirements.



High Performance, Leak-Resistant Hydraulic Pump



Tandem Load Wheels

800 mm  
**SHORT**

**Capacity** : 2500 kg  
**Height Lowered** : 85 mm  
**Lift Height** : 115 mm  
**Ground Clearance** : 35 mm

**Tyre Types** : PU - Nylon  
**Steering Wheels** : Ø200 x 50  
**Load Wheels** : Ø80 x 70  
**Wheel # Steer/Load** : 2/4



**MANUAL PALLET TRUCK | LONG (1500 mm)**

**2500 KG**

The **YAPAR PRO YPT25 Manual Long Hand Pallet Truck** enables easy handling of long and oversized pallets with its **1500 mm fork length and 2500 kg load capacity**.

Polyurethane and Nylon wheel options provide reliable performance on various floor surfaces.

Equipped with a durable hydraulic pump system, this model ensures reliable and comfortable operation with its ergonomic handle and quiet driving advantage. It is ideal for use in warehouses, logistics centers, and industrial environments.



PU - Nylon Steering Wheel option

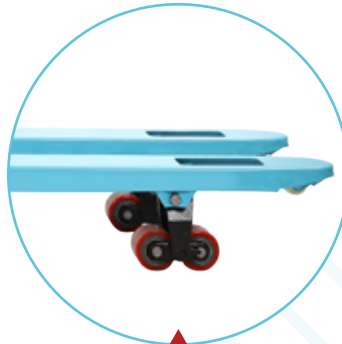

Tandem Load Wheels

**1500 mm LONG**

<b>Capacity</b>	: 2500 kg	<b>Tyre Types</b>	: Nylon
<b>Height Lowered</b>	: 85 mm	<b>Steering Wheels</b>	: Ø200 x 50
<b>Lift Height</b>	: 115 mm	<b>Load Wheels</b>	: Ø80 x 70
<b>Ground Clearance</b>	: 35 mm	<b>Wheel No (Steer/Load)</b>	: 2/4

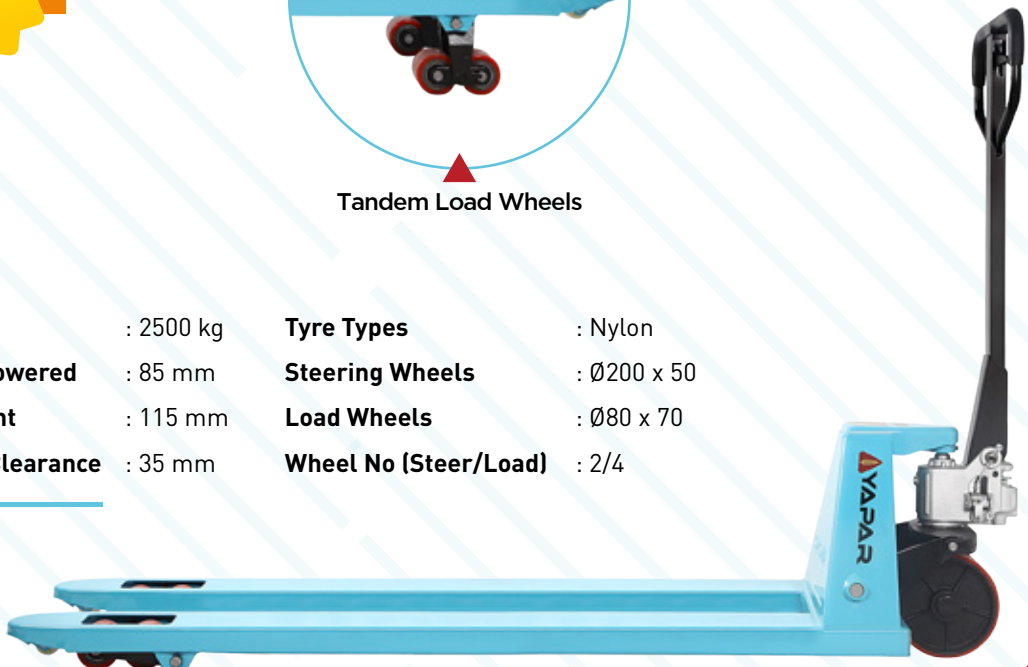

The **YAPAR PRO YPT20 Manual Extra-Long Hand Pallet Truck** is designed for easy handling of long and oversized pallets with its 2000 mm fork length, 2000 kg load capacity, and durable hydraulic pump system. Polyurethane and Nylon wheel options ensure reliable performance on various floor surfaces.

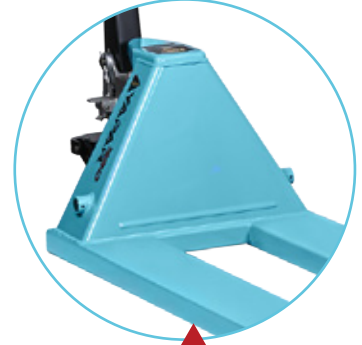

Long lasting robot welding chassis



**2000 mm  
EXTRA LONG**

Alternative Steering And Load Wheels

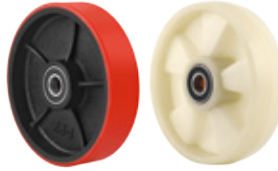

PU - Nylon Steering Wheels  
• Ø 200x 50



PU - Nylon Load Wheels  
• Ø 80 x 70

**Capacity** : 2000 kg

**Height Lowered** : 85 mm

**Lift Height** : 115 mm

**Ground Clearance** : 35 mm

**Tyre Types** : PU - Nylon

**Steering Wheels** : Ø200 x 50

**Load Wheels** : Ø80 x 70

**Wheel # Steer/Load** : 2/4

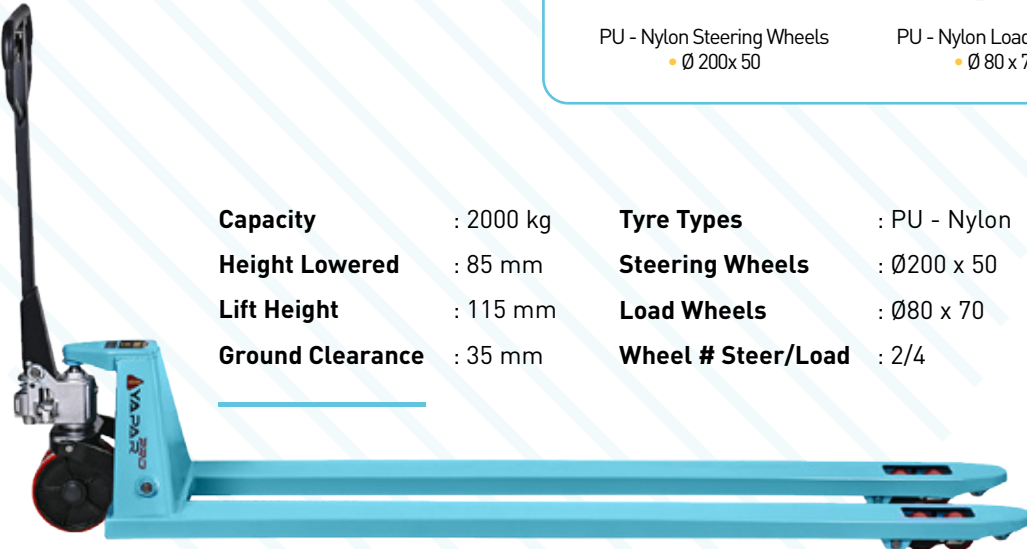

**MANUAL PALLET TRUCK | CONSTRUCTION TYPE**

**2500 KG**

Equipped with a fully automatic robot-welded chassis and a high-quality hydraulic pump, the YAPAR PRO YPT25 Construction-Type Hand Pallet Truck undergoes a precision manufacturing process. Thanks to the press rib fork design, standard reinforcements under the forks, and 8 grease fittings, it provides a longer service life.

The ergonomic handle ensures comfortable operation, while the non-slip coverage enhances safety during use.

Entry and exit roller wheels, which facilitate effortless pallet entry and improve stability, are standard features of the product.

Polyurethane and Nylon load and steering wheel options offer users the flexibility to choose the most suitable YPT25 pallet truck model according to their needs.

**CONSTRUCTION**



Press rib forks



Grease Fitting



Grease fittings at 8 different points

<b>Capacity</b>	: 2500 kg	<b>Tyre Types</b>	: PU - Nylon
<b>Height Lowered</b>	: 85 mm	<b>Steering Wheels</b>	: Ø200 x 50
<b>Lift Height</b>	: 115 mm	<b>Load Wheels</b>	: Ø80 x 70
<b>Ground Clearance</b>	: 35 mm	<b>Wheel No (Steer/Load)</b>	: 2/4

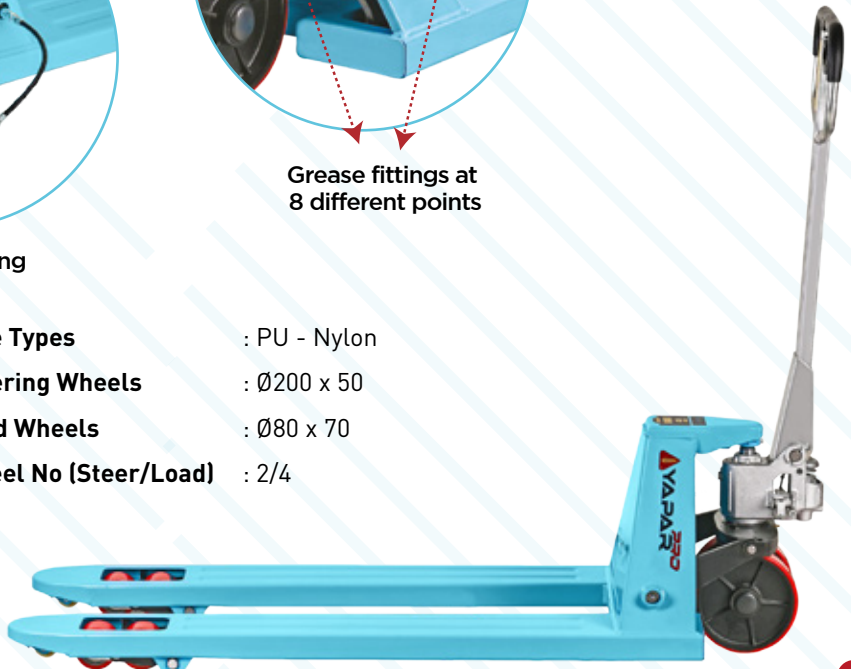

**Manual Hand Pallet Truck is specially galvanized coated for application in humid environments such as food processing plants, dairies and chemical industries.**

- All main parts of the pallet truck is galvanized, including fork frame, hydraulic pump, casting parts, handle and etc.
- Fully automatic robot welding chassis lead to consistent production and longer usage time.
- Nylon steering and load wheels are standard option for humid environment applications.
- With the standard reinforcing stiffeners under forks, **YAPAR YPT 25G** is the combination of well designed structure and quality.
- Equipped with high quality integrated hydraulic pump, which offers long life time with low maintenance.



**GALVANIZED**

Alternative steering and load wheels



Nylon steering wheels  
• Ø200x50 • Ø180x50



Nylon load wheels  
• Ø80x70



Tandem Load Wheels

<b>Capacity</b>	: 2500 kg	<b>Tyre Types</b>	: Nylon
<b>Height Lowered</b>	: 85 mm	<b>Steering Wheels</b>	: Ø200 x 50 - Ø180 x 50
<b>Lift Height</b>	: 115 mm	<b>Load Wheels</b>	: Ø80 x 70
<b>Ground Clearance</b>	: 35 mm	<b>Wheel No (Steer/Load)</b>	: 2/4

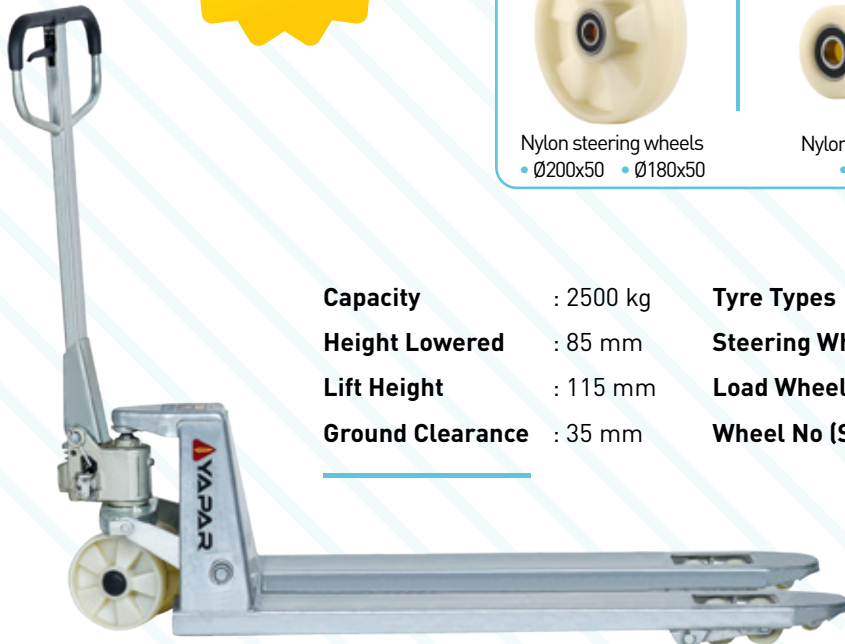

# MANUAL PALLET TRUCK | INOX STAINLESS STEEL



## YPT25P

2500 KG

- The main parts of the pallet truck, such as forks, control handle, etc. are made of stainless steel material.
- Fully automatic robot welding chassis lead to consistent production and longer usage time.
- Nylon steering and load wheels are standard option for humid environment applications.
- With the standard reinforcing stiffeners under forks, **YAPAR PRO YPT 20P** is the combination of well designed structure and quality.
- Equipped with high quality integrated hydraulic pump, which offers long life time with low maintenance.



Ergonomic and comfortable handle with anti-slippery coverage



Fully automated robot welding chassis



Leak-proof and reliable hydraulic pump

**INOX STAINLESS STEEL**

<b>Capacity</b>	: 2500 kg
<b>Height Lowered</b>	: 85 mm
<b>Lift Height</b>	: 115 mm
<b>Ground Clearance</b>	: 35 mm

<b>Tyre Types</b>	: Nylon
<b>Steering Wheels</b>	: Ø180 x 50
<b>Load Wheels</b>	: Ø80 x 70
<b>Wheel # Steer/Load</b>	: 2/4

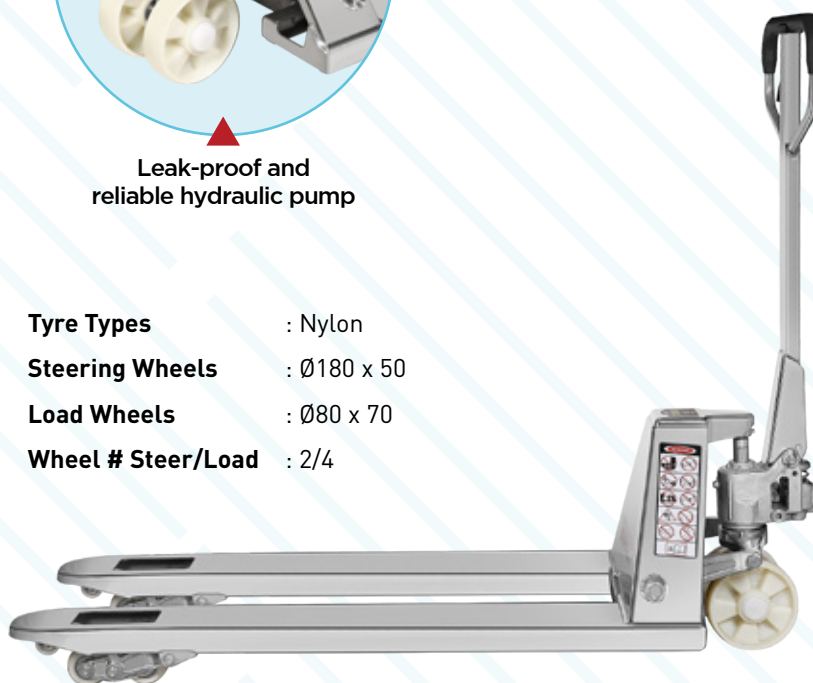

### High Accuracy

Weighing is performed with an accuracy of 0.1%, even in abnormal ground conditions or not properly loaded position. The measurement accuracy is high.

### Tare Weighing and Count Function

Tare weighing can be done easily with Z/T key. Thanks to the counting function, the average number of products can be easily counted when the pallet is loaded.

### Battery Specification

Equipped with rechargeable 6V/1,3 Ah battery which can be easily recharge with DC 9V/1A power adapter. With full charge, device can be used up to 30 hours. There is also a low battery warning. After "LO" appears on the screen, charging is required.

### Water and Dust Proof

It is sufficiently protected against ingress of dust to prevent the product from operating normally, but it is not dustproof. The product is fully protected against solid objects and splashes from any angle. The washing process is not suitable due to high pressure water can be used.

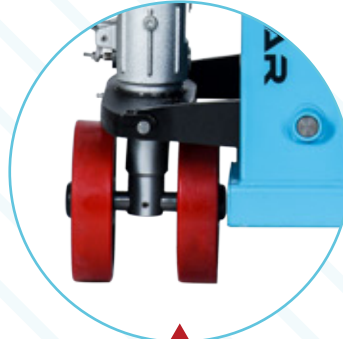

Leak-proof and reliable hydraulic pump



Long lasting high quality wheels

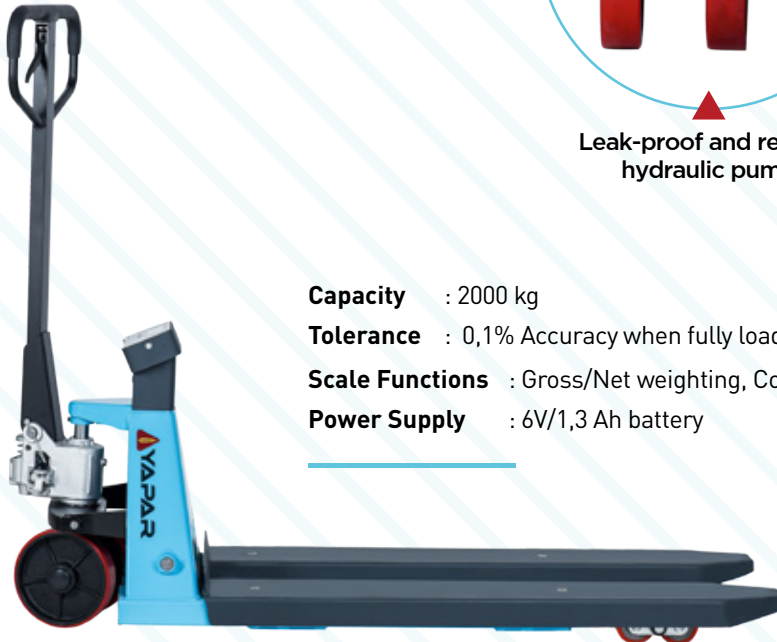

**Capacity** : 2000 kg  
**Tolerance** : 0,1% Accuracy when fully loaded  
**Scale Functions** : Gross/Net weighting, Count Function  
**Power Supply** : 6V/1,3 Ah battery

**Total Fork Width:** 560 mm  
**Width Per Fork:** 180 mm  
**Fork Length:** 1150 mm  
**Fork Height:** 85 mm



**2000 KG**

**Tare Weighing and Count Function**

Tare weighing can be done easily with TARE HOLD key. Thanks to the counting function, the average number of products can be easily counted when the pallet is loaded.

**Battery Specification**

Equipped with rechargeable 6V/4 Ah battery which can be easily recharge with DC 9V/1A power adapter. With full charge, device can be used up to 30 hours. There is also a low battery warning. After "LO" appears on the screen, charging is required.

**Water and Dust Proof**

It is sufficiently protected against ingress of dust to prevent the product from operating normally, but it is not dustproof. The product is fully protected against solid objects and splashes from any angle. The washing process is not suitable due to high pressure water can be used.



**Steering and load wheels**



Polyurethane steering wheels  
• Ø180x50



Polyurethane load wheels  
• Ø70x60

**HIGH MEASUREMENT ACCURACY**

- Weighing is performed in 0,5 kg steps.
- Measurements can be read easily with High Contrast Display.
- Screen backlight is available.
- There is an adjustable automatic shut down option (10 min) and low battery warning.

**Capacity** : 2000 kg

**Tolerance** : 0,1% Accuracy when fully loaded

**Scale Functions** : Gross/Net weighting, Count Function

**Power Supply** : 6V/4 Ah battery

**Total Fork Width:** 560 mm

**Width Per Fork:** 180 mm

**Fork Length:** 1150 mm

**Fork Height:** 85 mm





LIGHTEN YOUR  
LOAD, SIMPLIFY  
YOUR WORK WITH  
MAXIMUM  
PERFORMANCE  
AND HIGH  
EFFICIENCY.



[yaparmaterialhandling.com](http://yaparmaterialhandling.com)

[yaparlarm.com](http://yaparlarm.com)

## **ELECTRIC PALLET TRUCKS**

**Electric Pallet Truck** is engineered for comfortable and efficient operation, featuring a multifunctional ergonomic handle for enhanced control. Powered by a lithium-ion battery, it delivers reliable performance for high-demand applications.



**Multi-function Ergonomic Handle**



**Additional Balance Wheels**



**Fully Automated Robot Welding Chassis**



**Capacity** : 1500 kg  
**Fork Dimensions** : 1150x550 mm  
**Min. Fork Height** : 85 mm  
**Max. Fork Height** : 200 mm  
**Forward and Reverse Driving** : Electric  
**Lifting and Lowering** : Electric  
**Brake Type** : Regenerative

**Wheel Type** : Polyurethane (PU)  
**Steering Wheel** : Ø155x50  
**Load Wheels** : Ø80x70  
**Wheel No (Steering-Load)** : 1-4  
**Unladen Speed** : 4,5 km/h  
**Laden Speed** : 4 km/h  
**Brake Mechanism** : Electromagnetic



**Lithium-ion Battery**  
48V/15Ah



**5A Smart Charger**



# ELECTRIC PALLET TRUCK



**2000 KG**

- Safe and Durable
- High Performance Hydraulic Pump and Battery
- Easily Accessible Spare Parts

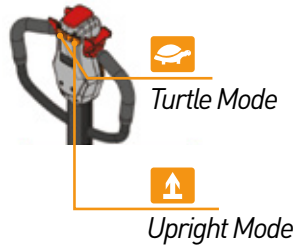

Emergency Reverse Button

Horn

Forward/Reverse Butterfly Switch

Lifting/Lowering

Brushless Motor

**LCD Screen**  
 - Battery indicator with hour meter  
 - **Error code display**  
 - Recharge alert

**Capacity** : 2000 kg  
**Fork Dimensions** : 1150x550 mm  
**Min. Fork Height** : 85 mm  
**Max. Fork Height** : 200 mm  
**Forward and Reverse Driving** : Electric  
**Lifting and Lowering** : Electric  
**Brake Type** : Regenerative

**Wheel Type** : Polyurethane (PU)  
**Steering Wheel** : Ø155x50  
**Load Wheels** : Ø80x70  
**Wheel No (Steering-Load)** : 1-4  
**Unladen Speed** : 4,5 km/h  
**Laden Speed** : 4 km/h  
**Brake Mechanism** : Electromagnetic

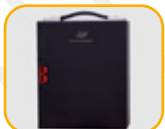

Lithium-ion Battery  
48V/15Ah



5A Smart Charger



Tandem Load Wheels





[yaparmaterialhandling.com](http://yaparmaterialhandling.com)  
[yaparlarm.com](http://yaparlarm.com)

**HAND TRUCKS**

**PLATFORM TRUCKS**

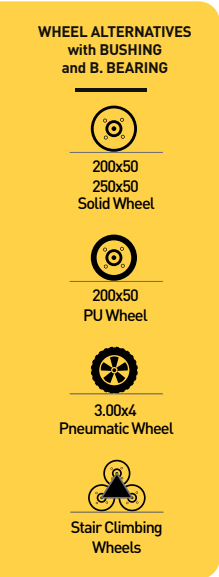
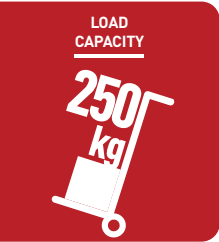
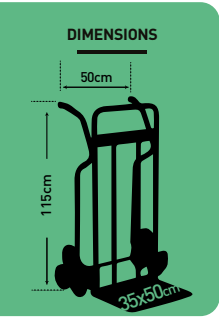

**Wheel Alternatives**

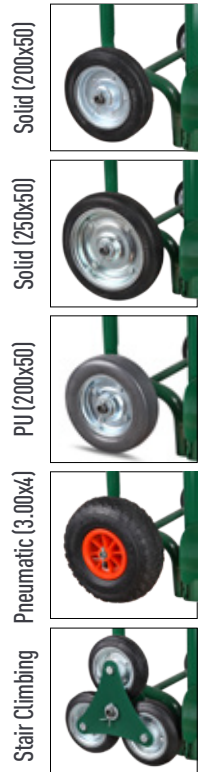

Wide, reinforced loadspace	Robust, durable and aesthetic body structure	Ergonomic handle suitable for carrying height
One-handed drag and maneuverability	Special design for the least feeling of the load in the carrying position	Wheel protector and loadspace extender
Different wheel alternatives		

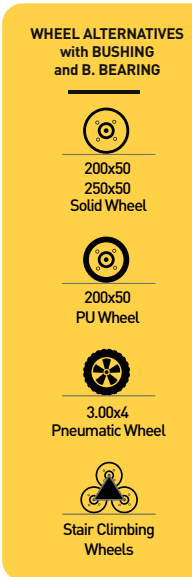
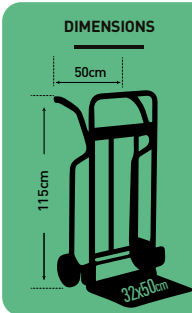

Foldable, wide and sturdy loadspace	Robust, durable and aesthetic body structure	Ergonomic handle suitable for carrying height
One-handed drag and maneuverability	Special design for the least feeling of the load in the carrying position	Wheel protector and loadspace extender
Different wheel alternatives	Easy storage and space saving with folding loadspace	

### DIMENSIONS

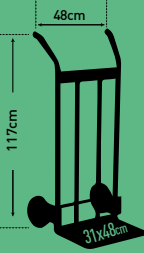

### WHEEL ALTERNATIVES with BUSHING and B. BEARING



200x50  
250x50  
Solid Wheel



3.00x4  
Pneumatic Wheel



Stair Climbing

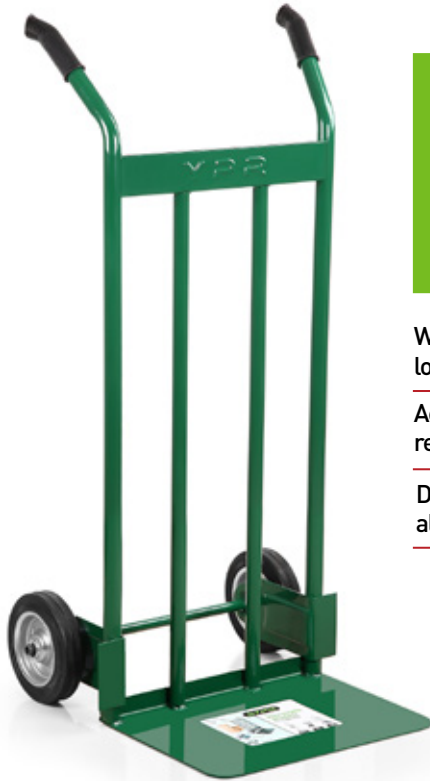

Wide and sturdy loadspace

Aesthetic resistant frame

Different wheel alternatives

## HT200 HAND TRUCK

Easy to carry bulky products with its high body

Special design for the least feeling of the load in the carrying position

### Wheel Alternatives

Solid (200x50)



Solid (250x50)



PU (200x50)



Pneumatic (3.00x4)



Stair Climbing



### DIMENSIONS

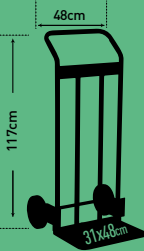

### WHEEL ALTERNATIVES with BUSHING and B. BEARING



200x50  
250x50  
Solid Wheel



3.00x4  
Pneumatic Wheel



Stair Climbing

## HT205 HAND TRUCK

One-handed drag and maneuverability

Aesthetic resistant frame

Easy to carry bulky products with its high body

Special design for the least feeling of the load in the carrying position

Different wheel alternatives



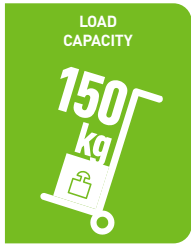

## HT210 FOLDING HAND TRUCK

Foldable, wide and sturdy loadspace	Easy to carry bulky products with its high body	Ergonomic hand grip
Aesthetic resistant frame	Special design for the least feeling of the load in the carrying position	Easy storage and space saving with folding loadspace
Different wheel alternatives		

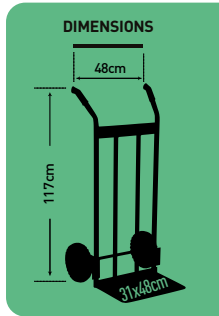

### WHEEL ALTERNATIVES with BUSHING and B. BEARING



200x50  
250x50  
Solid Wheel



3.00x4  
Pneumatic Wheel



Stair Climbing

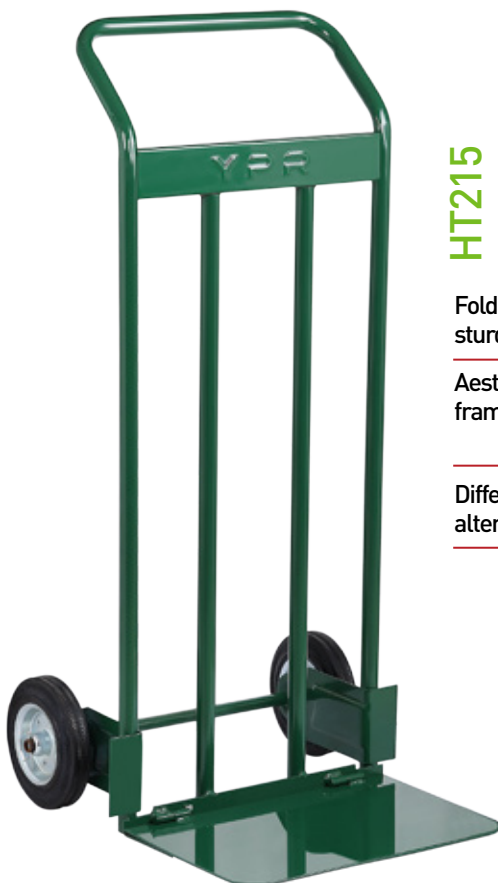

## HT215 FOLDING HAND TRUCK

Foldable, wide and sturdy loadspace	Easy to carry bulky products with its high body	Ergonomic hand grip
Aesthetic resistant frame	Special design for the least feeling of the load in the carrying position	Easy storage and space saving with folding loadspace
Different wheel alternatives		

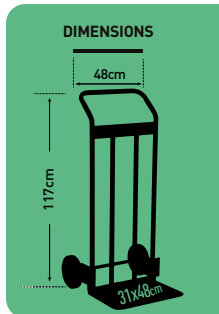

### WHEEL ALTERNATIVES with BUSHING and B. BEARING



200x50  
250x50  
Solid Wheel



3.00x4  
Pneumatic Wheel



Stair Climbing

**DIMENSIONS**



**WHEEL ALTERNATIVES**  
with BUSHING  
and B. BEARING



200x50  
Solid Wheel



3.00x4  
Pneumatic Wheel



Stair Climbing



## HT100 HAND TRUCK

Ergonomic hand grip

Special design for the least feeling of the load in the carrying position

Ideal for small works

Different wheel alternatives

Wheel Alternatives

Solid (200x50)



Solid (250x50)



PU (200x50)



Pneumatic (3.00x4)



Stair Climbing



**DIMENSIONS**

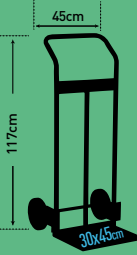

**WHEEL ALTERNATIVES**  
with BUSHING  
and B. BEARING



200x50  
Solid Wheel



3.00x4  
Pneumatic Wheel



Stair Climbing

## HT105 HAND TRUCK

One-handed drag and maneuverability

Special design for the least feeling of the load in the carrying position

Different wheel alternatives

Ideal for small works

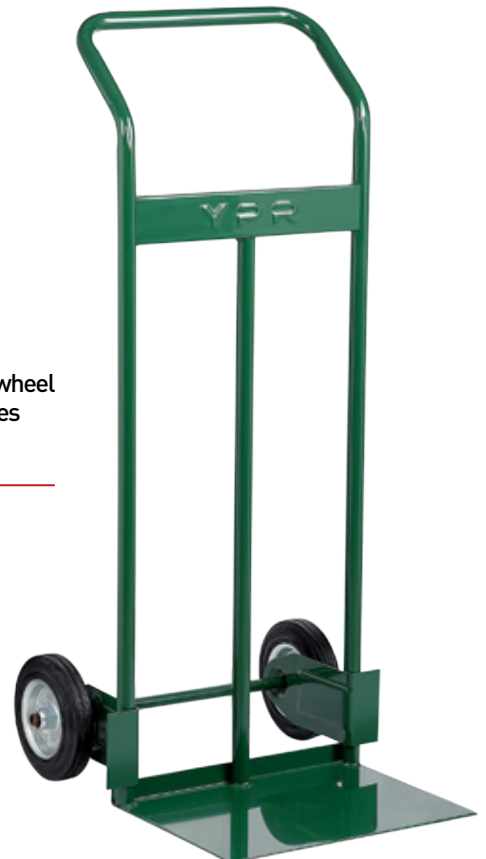

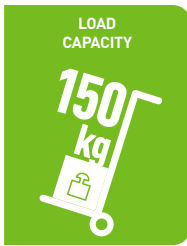

## HT140 HAND TRUCK

Different wheel alternatives	Special design for the least feeling of the load in the carrying position
Special design frame	Ergonomic hand grip

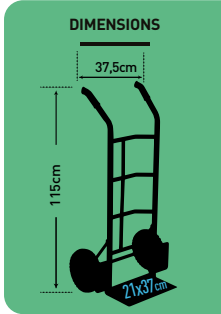

**WHEEL ALTERNATIVES with BUSHING and B. BEARING**

- 200x50 Solid Wheel
- 200x50 PU Wheel
- 3.00x4 Pneumatic Wheel



## HT120 HAND TRUCK

Ideal for small works	Special design for the least feeling of the load in the carrying position
Ergonomic hand grip	Different wheel alternatives

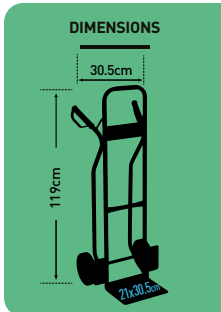

**WHEEL ALTERNATIVES with BUSHING and B. BEARING**

- 200x50 Solid Wheel
- 200x50 PU Wheel
- 3.00x4 Pneumatic Wheel

YAPAR Platform Trucks, produced with YAPARLAR's sensitive quality understanding and meticulous manufacturing assurance, were presented to the consumer in the first stage with two different sizes and two different loadspace alternatives. These models, which have a load capacity of 150 kg and 250 kg, can be preferred with a metal sheet base or plywood base. The detachable pushing handle provides advantages in storage and transportation.



KOD	axbxc		Loadspace	
81720	60x102x90 cm	Solid w/Bushing (125x40)	60x86 cm	1

**PP250P PLATFORM TRUCKS**

Thanks to the disassembled pushing handle, transport and stacking advantage

**PATTERNED PLYWOOD BASE**

KOD	axbxc		Loadspace	
81722	60x102x90 cm	Solid w/Bushing (125x40)	60x86 cm	1



Ergonomic push height and one-hand use

Special anti-slippery paint

150 kg Load Capacity

Easy maneuverability with swivel wheels

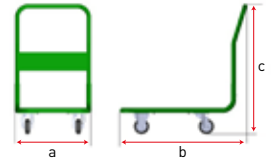

KOD	axbxc		Loadspace	
81710	50x83x85 cm	Solid w/Bushing (100x35)	50x67 cm	1

# PP150P PLATFORM TRUCKS



Ergonomic push height and one-hand use

Thanks to the disassembled pushing handle, transport and stacking advantage

150 kg Load Capacity

Special anti-slippery patterned loadspace



KOD	axbxc		Loadspace	
81712	50x83x85 cm	Solid w/Bushing (100x35)	50x67 cm	1

## SOLID WHEEL (250 X 50)



KOD			
64112	w/ Bushing	200 kg	6
64122	w/ B. Bearing	250 kg	6

## SOLID WHEEL (200 x 50)



KOD				
64111	w/ Bushing	200 kg	1.52 kg	6
64121	w/ B. Bearing	250 kg	1.75 kg	6
64331	w/ Pls. Rim	200 kg	1.21 kg	6

## SOLID WHEEL (150 X 45)



KOD				
64411	w/ Bushing	150 kg	0.86 kg	10
67506	Spare Shaft Bolt-Nut	-	0.09 kg	6

## STAIR CLIMBING 3 WHEEL SET



KOD				
64510	w/ Bushing	300 kg	3.25 kg	2

## SOLID WHEEL w/ PLATE (125x40)



KOD				
64610	Fixed	125 kg	1.00 kg	10
64612	Swivel	125 kg	1.20 kg	10



## SOLID WHEEL w/ PLATE (100x35)



KOD				
64620	Fixed	100 kg	0.75 kg	10
64622	Swivel	100 kg	0,97 kg	10



## PU Steering Wheels



Polyurethane steering wheels  
• Ø200x50



Polyurethane steering wheels  
• Ø180x50

## PU Load Wheels



Polyurethane load wheels  
• Ø70x60



Polyurethane load wheels  
• Ø80x70



Polyurethane load wheels  
• Ø80x90

## NYLON Steering Wheels



Nylon steering wheels  
• Ø200x50



Nylon steering wheels  
• Ø180x50

## NYLON Load Wheels



Nylon steering wheels  
• Ø70x60



Nylon steering wheels  
• Ø80x90

## RUBBER Steering Wheels



RUBBER Steering Wheels  
• Ø200x50

## Handle Bars



Ergonomic and comfortable handle with anti-slippery coverage



Round type handle

## Hydraulic Pumps



BF type casting hydraulic pump



DF type casting hydraulic pump



Conforms to EN ISO3691-5  
Based on Directive 2006/42/EC

**ISO 9001**  
**ISO 14001**  
**ISO 45001**



**YAPARLAR İNŞAAT VE TARIM ALETLERİ SANAYİ VE TİCARET A.Ş.**

**Head Office and İstanbul Factory:**

Cebeci Cad. No. 115 Küçükköy 34250 İstanbul / TÜRKİYE  
T. +90 212 477 27 37 F. +90 212 538 00 25  
info@yaparlar.com / export@yaparlar.com

**Çayırova Factory:**

TOSB Otomotiv Tedarik Sanayi İhtisas Organize Sanayi Bölgesi  
TOSB Otomotiv Mah. (OSB Mah.) 15. Sok. 41420  
Şekerpinar Çayırova Kocaeli / TÜRKİYE

yaparlar.com

yaparmaterialhandling.com

/yaparlarcomtr

/yaparmaterialhandling

©2026 | YAPARLAR İNŞAAT VE TARIM ALETLERİ SANAYİ VE TİCARET A.Ş.

All rights reserved | Specifications subject to change without notice